

Description

The PTVSHC1DF15VB transient voltage suppressor is designed to replace multilayer varistors (MLVs) in portable applications such as cell phones, notebook computers, and PDA's. They feature large cross-sectional area junctions for conducting high transient currents, offer desirable electrical characteristics for board level protection, such as fast response time, lower operating voltage, lower clamping voltage and no device degradation when compared to MLVs. The PTVSHC1DF15VB protects sensitive semiconductor components from damage or upset due to electrostatic discharge (ESD) and other voltage induced transient events. The PTVSHC1DF15VB is available in a SOD-123FL package with working voltages of 15 volt.

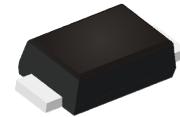

SOD-123FL(Top View)

Feature

- 2200W Peak pulse power per line ($t_p = 8/20\mu s$)
- SOD-123FL package
- Response time is typically $< 1\text{ ns}$
- Protect one I/O or power line
- Low clamping Voltage
- RoHS compliant
- Transient protection for data lines to IEC 61000-4-2(ESD) $\pm 30\text{KV(air)}$, $\pm 30\text{KV(contact)}$; IEC 61000-4-4 (EFT) 80A (5/50ns)

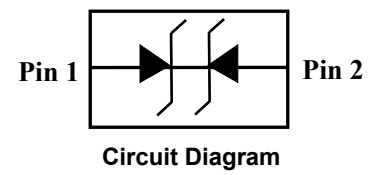

Applications

- Cell phone handsets and accessories
- Personal digital assistants (PDA's)
- Notebooks, desktops, and servers
- Portable instrumentation
- Cordless phones
- Digital cameras
- Peripherals
- MP3 players



Marking (Top View)

Mechanical Characteristics

- Lead finish: 100% matte Sn(Tin)
- Mounting position: Any
- Qualified max reflow temperature: 260°C
- Device meets MSL 1 requirements
- Pure tin plating: $7 \sim 17\ \mu\text{m}$
- Pin flatness: $\leq 3\text{mil}$

Electronics Parameter

Symbol	Parameter
V_{RWM}	Peak Reverse Working Voltage
I_R	Reverse Leakage Current @ V_{RWM}
V_{BR}	Breakdown Voltage @ I_T
I_T	Test Current
I_{PP}	Maximum Reverse Peak Pulse Current
V_C	Clamping Voltage @ I_{PP}
P_{PP}	Peak Pulse Power
C_J	Junction Capacitance

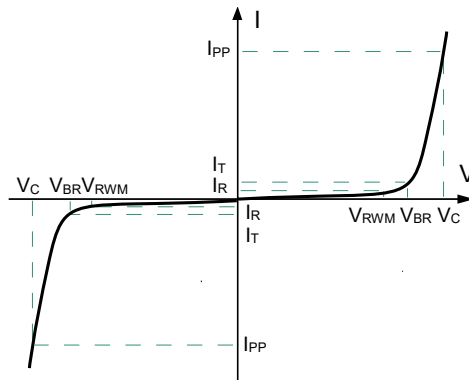

Electrical characteristics per line@25°C (unless otherwise specified)

Parameter	Symbol	Conditions	Min.	Typ.	Max.	Units
Peak Reverse Working Voltage	V_{RWM}				15	V
Breakdown Voltage	V_{BR}	$I_t = 1\text{mA}$	16.7	18.0	20.0	V
Reverse Leakage Current	I_R	$V_{RWM} = 15\text{V}$			1	μA
Clamping Voltage	V_C	$I_{PP} = 80\text{A}$ $t_p = 8/20\mu\text{s}$		28.0	30.0	V
Junction Capacitance	C_j	$V_R = 0\text{V}$ $f = 1\text{MHz}$		350	500	pF

Absolute maximum rating@25°C

Rating	Symbol	Value	Units
Peak Pulse Power ($t_p = 8/20\mu\text{s}$)	P_{PP}	2200	W
Lead Soldering Temperature	T_L	260 (10 sec)	$^{\circ}\text{C}$
Operating Temperature	T_J	-55 to +125	$^{\circ}\text{C}$
Storage Temperature	T_{STG}	-55 to +150	$^{\circ}\text{C}$

Typical Characteristics

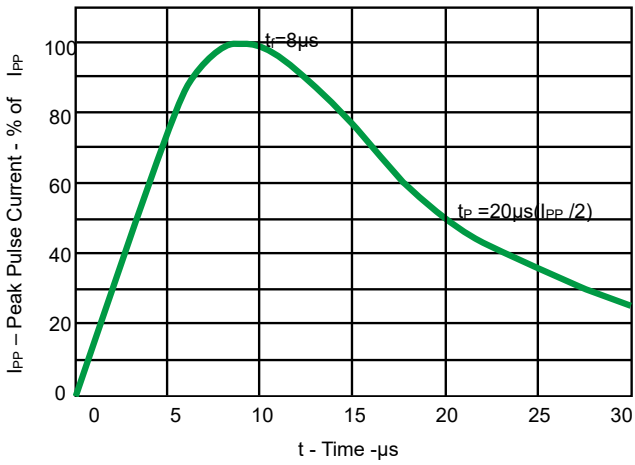

Fig 1. Pulse Waveform

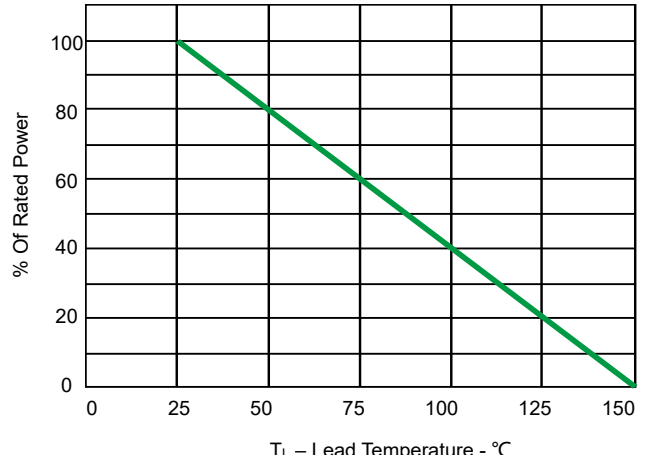

Fig 2. Power Derating Curve

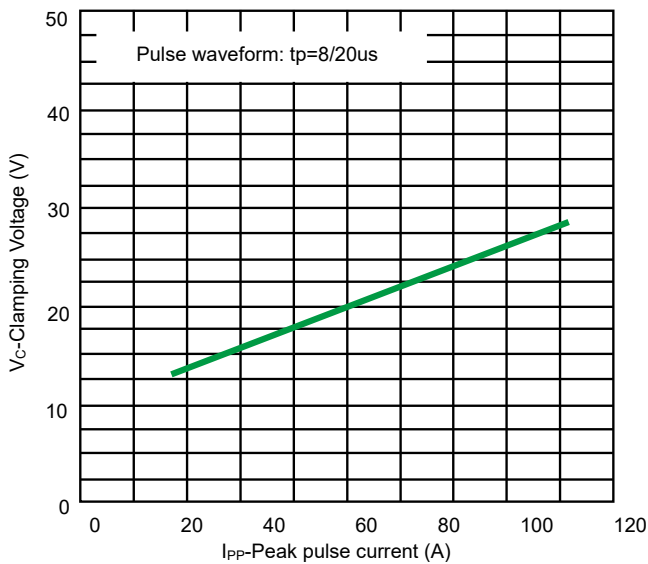

Fig 3. Clamping voltage vs. Peak pulse current

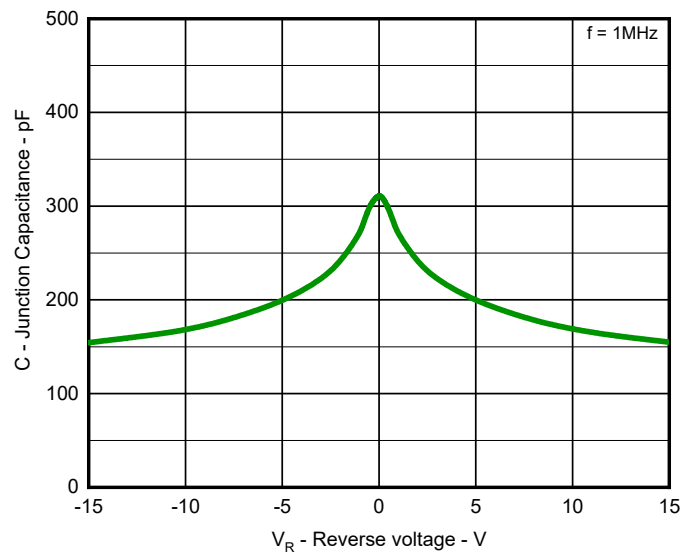

Fig 4. Capacitance vs. Reverse voltage

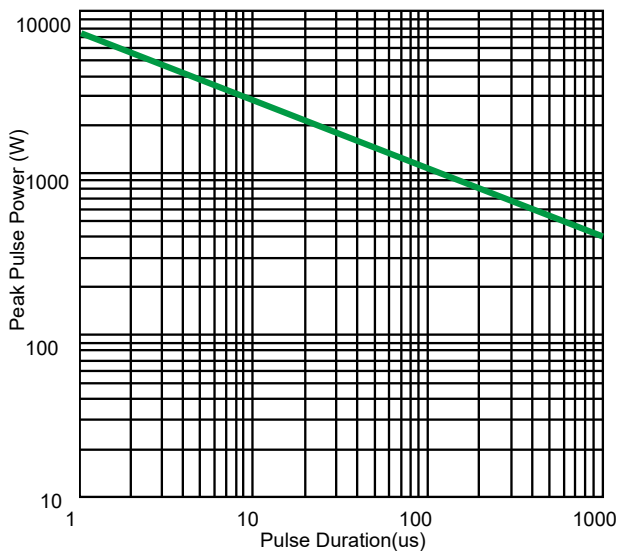
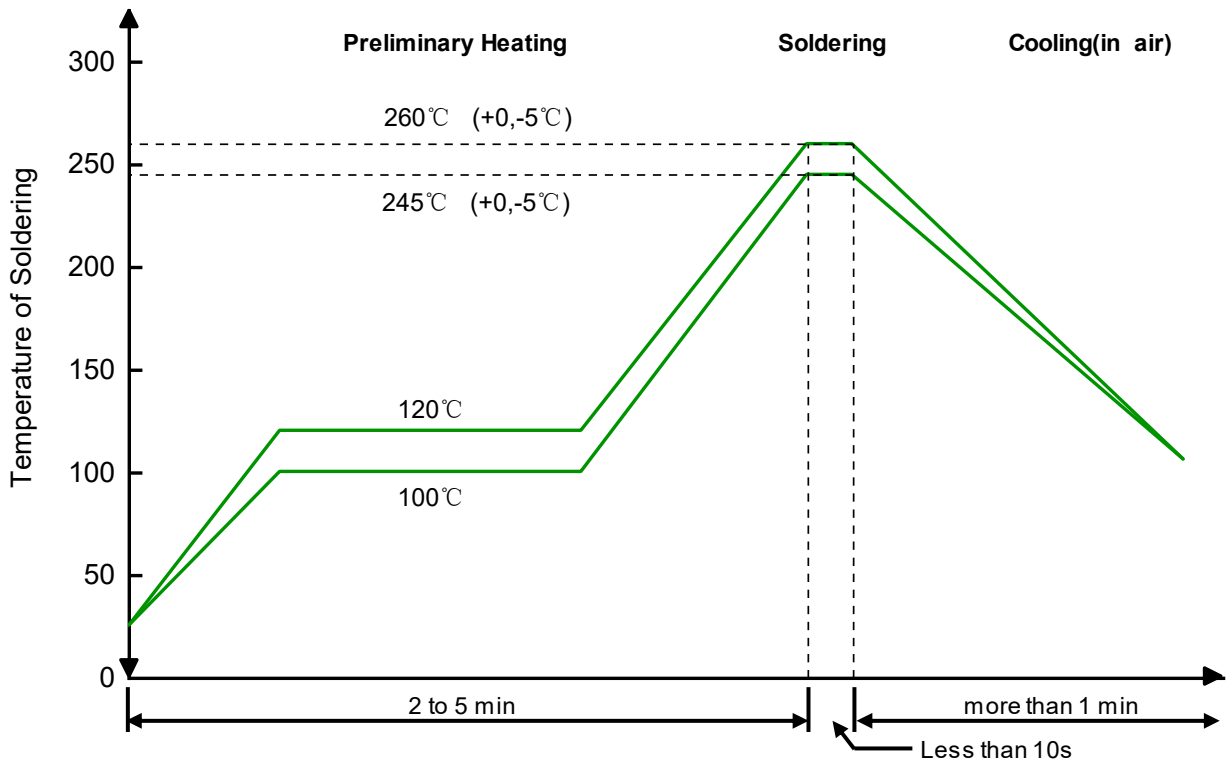

Fig 5. Non Repetitive Peak Pulse Power vs. Pulse time

Solder Reflow Recommendation



Remark: Pb free for 260°C; Pb for 245°C.

PCB Design

For TVS diodes a low-ohmic and low-inductive path to chassis earth is absolutely mandatory in order to achieve good ESD protection. Novices in the area of ESD protection should take following suggestions to heart:

- Do not use stubs, but place the cathode of the TVS diode directly on the signal trace.
- Do not make false economies and save copper for the ground connection.
- Place via holes to ground as close as possible to the anode of the TVS diode.
- Use as many via holes as possible for the ground connection.
- Keep the length of via holes in mind! The longer the more inductance they will have.

Product dimension (SOD-123FL)

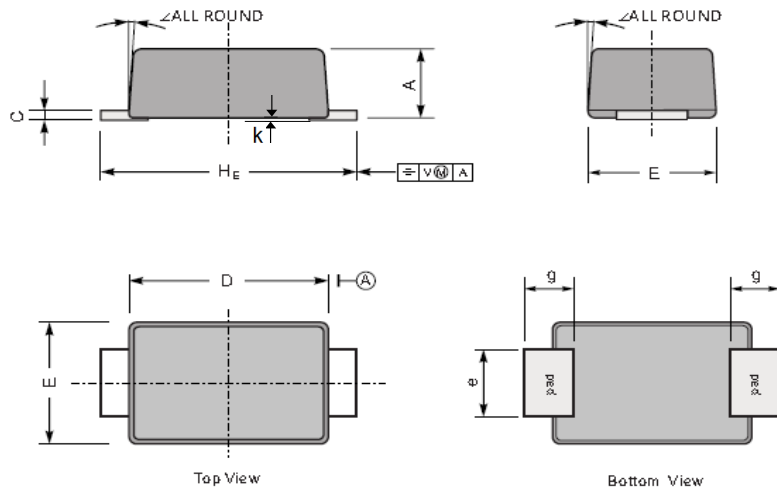

Dim	Inches		Millimeters	
	MIN	MAX	MIN	MAX
A	0.031	0.047	0.80	1.20
C	0.002	0.010	0.05	0.25
H _E	0.138	0.154	3.50	3.90
E	0.061	0.077	1.55	1.95
D	0.098	0.114	2.50	2.90
g	0.020	0.043	0.50	1.10
e	0.024	0.039	0.60	1.00
k	0.004		0.10	
∠	7°			

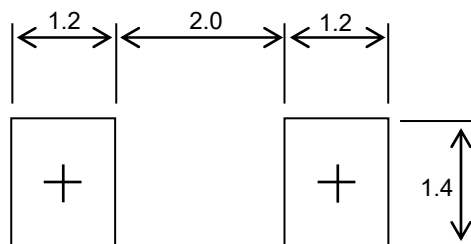

Suggested PCB Layout Unit:mm

Ordering information

Device	Package	Reel	Shipping
PTVSHC1DF15VB	SOD-123FL	7"	3000 / Tape & Reel

Load with information

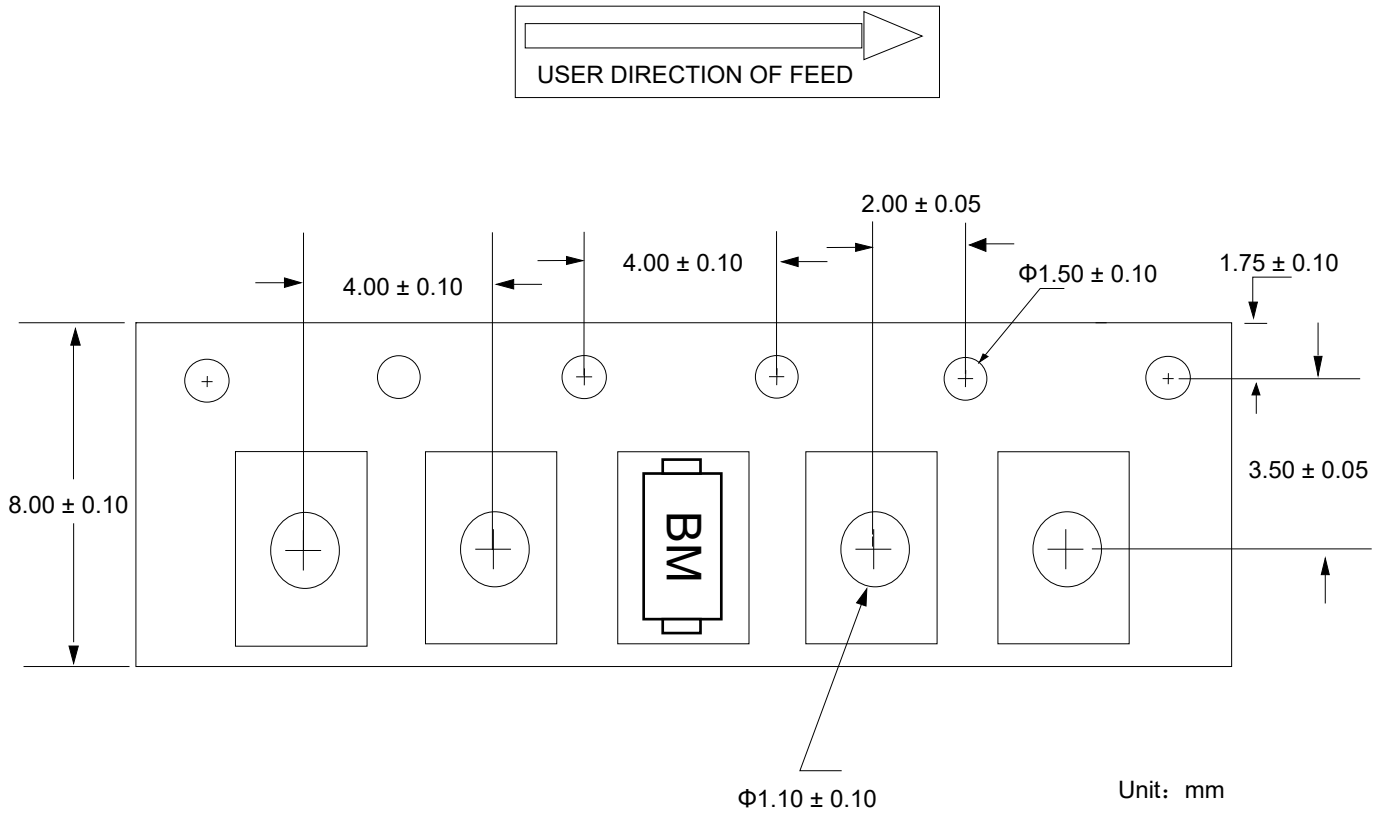

IMPORTANT NOTICE

 and **Prisemi**[®] are registered trademarks of **Prisemi Electronics Co., Ltd** (Prisemi). Prisemi reserves the right to make changes without further notice to any products herein. Prisemi makes no warranty, representation or guarantee regarding the suitability of its products for any particular purpose, nor does Prisemi assume any liability arising out of the application or use of any product or circuit, and specifically disclaims any and all liability, including without limitation special, consequential or incidental damages. "Typical" parameters which may be provided in Prisemi data sheets and/or specifications can and do vary in different applications and actual performance may vary over time. All operating parameters, including "Typicals" must be validated for each customer application by customer's technical experts. Prisemi does not convey any license under its patent rights nor the rights of others. The products listed in this document are designed to be used with ordinary electronic equipment or devices, Should you intend to use these products with equipment or devices which require an extremely high level of reliability and the malfunction of which would directly endanger human life (such as medical instruments, aerospace machinery, nuclear-reactor controllers, fuel controllers and other safety devices), please be sure to consult with our sales representative in advance.

Website: <http://www.prisemi.com>

For additional information, please contact your local Sales Representative.

©Copyright 2009, Prisemi Electronics

 **Prisemi**[®] is a registered trademark of Prisemi Electronics.

All rights are reserved.