

Description

The PSJMTOF65R280 is a high voltage MOSFET and is designed to have better characteristics, such as fast switching time, low gate charge, low on-state resistance and have a high rugged avalanche characteristics. This power MOSFET is usually used at high speed switching applications in power supplies, PWM motor controls, high efficient DC to DC converters and bridge circuits.

MOSFET Product Summary

$V_{DS}(V)$	$R_{DS(on)}(m\Omega)(Typ)$	$I_D(A)$
650	234@ $V_{GS} = 10V$	12

Feature

- Fast Switching Capability
- Lead free product is acquired.
- Avalanche Energy Tested

Applications

- PWM applications
- Load Switch
- Power Management
- DC-DC Converters

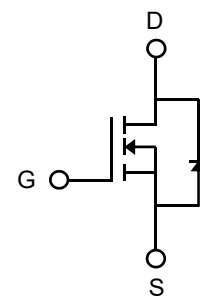
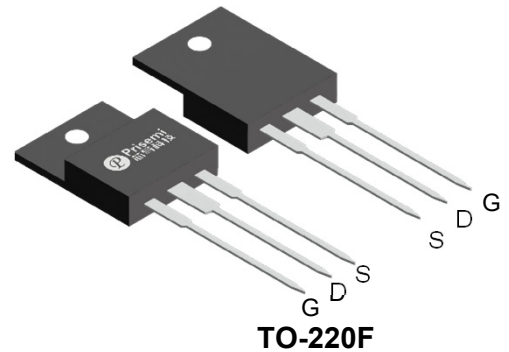

Circuit Diagram

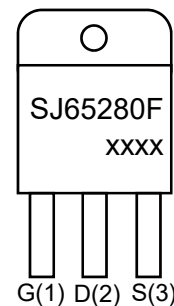

Marking (Top View)

Absolute maximum rating@25°C

Rating		Symbol	Value	Units
Drain-Source Voltage		V_{DS}	650	V
Gate-Source Voltage		V_{GS}	±30	V
Drain Current-Continuous ¹⁾	$T_C=25^\circ C$	I_D	12	A
	$T_C=100^\circ C$		7.6	
Pulsed Drain Current ²⁾		I_{DM}	36	A
Total Power Dissipation ³⁾		P_D	134	W
Avalanche Current ⁴⁾		I_{AS}	3.3	A
Avalanche Energy ⁴⁾		E_{AS}	444	mJ
Thermal Resistance , Junction-to-Case ⁶⁾		$R_{\theta JC}$	0.94	°C/W
Thermal Resistance , Junction-to-Ambient ⁵⁾		$R_{\theta JA}$	45.2	°C/W
Junction and Storage Temperature Range		T_J, T_{STG}	-55~+150	°C

Electrical characteristics per line@25°C (unless otherwise specified)

Parameter	Symbol	Conditions	Min.	Typ.	Max.	Units
Off Characteristics						
Drain-Source Breakdown Voltage	BV_{DSS}	$V_{GS} = 0V, I_D = 250\mu A$	650	-	-	V
Zero Gate Voltage Drain Current	I_{DSS}	$V_{DS} = 650V, V_{GS} = 0V$	-	-	1.0	μA
Gate-Body Leakage Current	I_{GSS}	$V_{GS} = \pm 30V, V_{DS} = 0V$	-	-	± 100	nA
On Characteristics						
Gate Threshold Voltage	$V_{GS(th)}$	$V_{DS} = V_{GS}, I_D = 250\mu A$	2.5	3.0	3.5	V
Drain-Source On-State Resistance	$R_{DS(ON)}$	$V_{GS} = 10V, I_D = 8A$	-	234	280	m Ω
Dynamic Characteristics⁷⁾						
Input Capacitance	C_{iss}	$V_{DS} = 100V, V_{GS} = 0V,$ $f = 1.0MHz$	-	800	-	pF
Output Capacitance	C_{oss}		-	34	-	
Reverse Transfer Capacitance	C_{rss}		-	1.2	-	
Switching Characteristics⁷⁾						
Turn-on Delay Time	$t_{d(on)}$	$V_{DS} = 380V, V_{GS} = 10V,$ $I_D = 8A, R_G = 2.3\Omega$	-	13	-	ns
Turn-on Rise Time	t_r		-	7.4	-	
Turn-Off Delay Time	$t_{d(off)}$		-	28.8	-	
Turn-Off Fall Time	t_f		-	5.1	-	
Total Gate Charge	Q_g	$V_{DS} = 480V, V_{GS} = 10V,$ $I_D = 15A$	-	18.8	-	nC
Gate-Source Charge	Q_{gs}		-	2.6	-	
Gate-Drain Charge	Q_{gd}		-	3.6	-	
Gate Resistance	R_g	$f=1MHz, \text{Open Drain}$	-	3.3	-	Ω
Drain-Source Diode Characteristics						
Diode Forward Voltage	V_{SD}	$V_{GS} = 0V, I_S = 8A$	-	0.85	1.2	V
Body Diode Reverse Recovery Time	t_{rr}	$I_F = 7.5A, V_R = 200V,$ $dI_F/dt = 100A/\mu s$	-	219	-	ns
Body Diode Reverse Recovery Charge	Q_{rr}		-	2.2	-	μC
Peak Reverse Recovery Current	I_{rrm}		-	19.7	-	A

Notes:

1. Computed continuous current assumes the condition of T_{J_Max} while the actual continuous current depends on the thermal & electro-mechanical application board design.
2. Repetitive Rating: Pulse width limited by maximum junction temperature($T_{J_Max}=150^\circ C$).
3. Pulse Test: Pulse Width $\leq 300\mu s$, Duty Cycle $\leq 2\%$.
4. This single-pulse measurement was taken under the following condition [$L=79.9mH, V_{GS}=10V, V_{DS}=100V$]while it's value is limited by $T_{J_Max}=150^\circ C$.
5. Device mounted on FR-4 substrate PC board, 2oz copper, with minimum recommended pad layout.
6. Device mounted on infinite heatsink.
7. Guaranteed by design, not subject to production.

Typical Characteristics

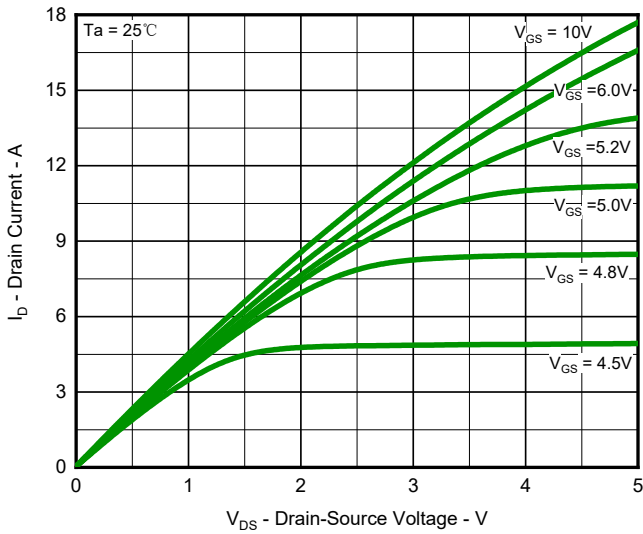

Fig.1 Output Characteristics

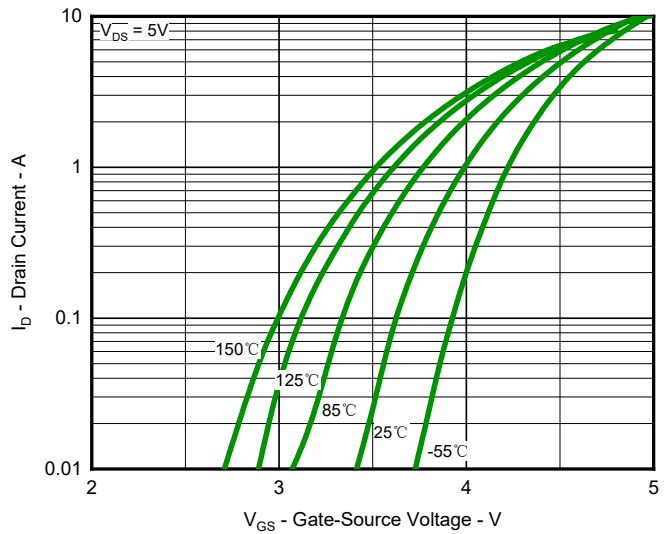

Fig.2 Typical Transfer Characteristic

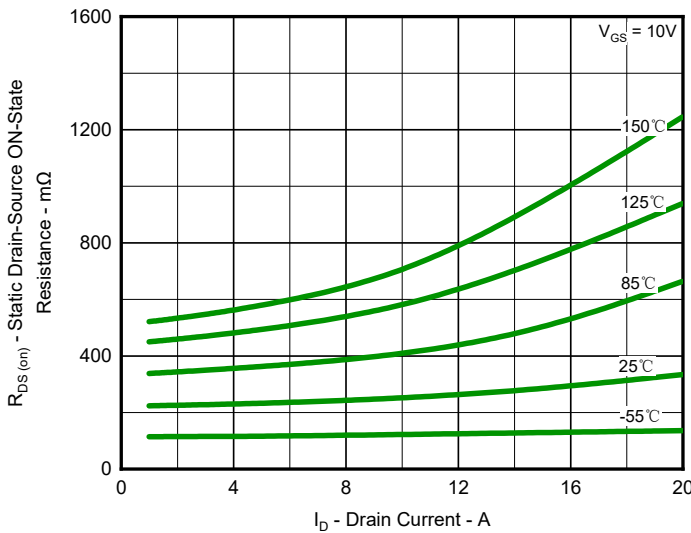

Fig.3 Typical On-Resistance vs Drain Current and Temperature

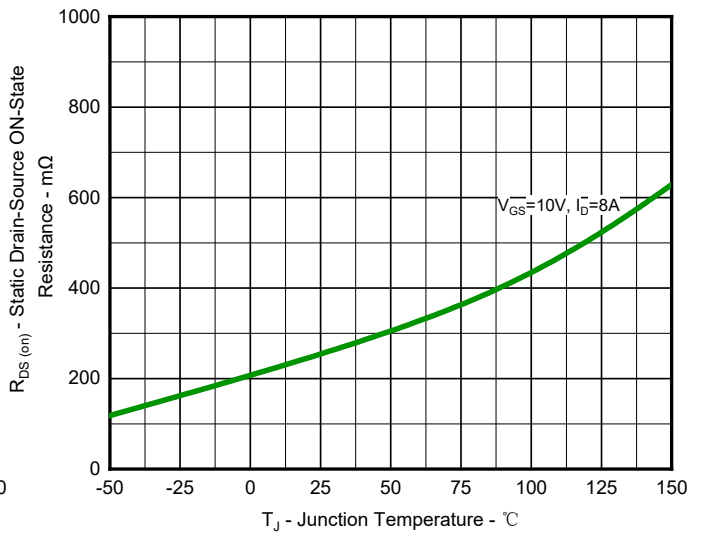

Fig.4 On-Resistance Variation with Temperature

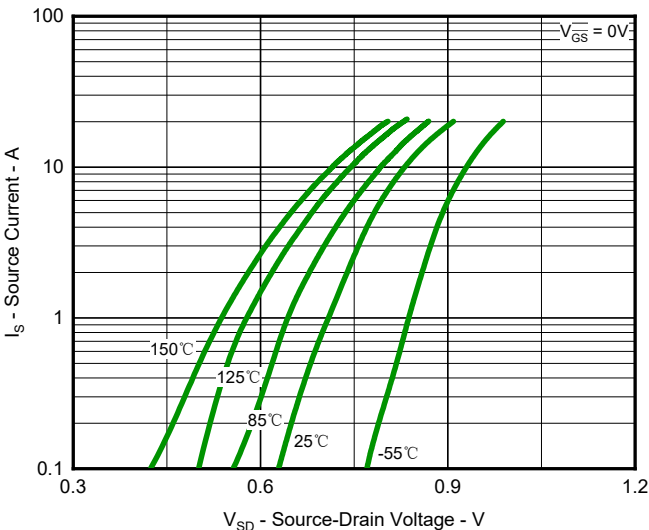

Fig.5 Diode Forward Voltage vs. Current

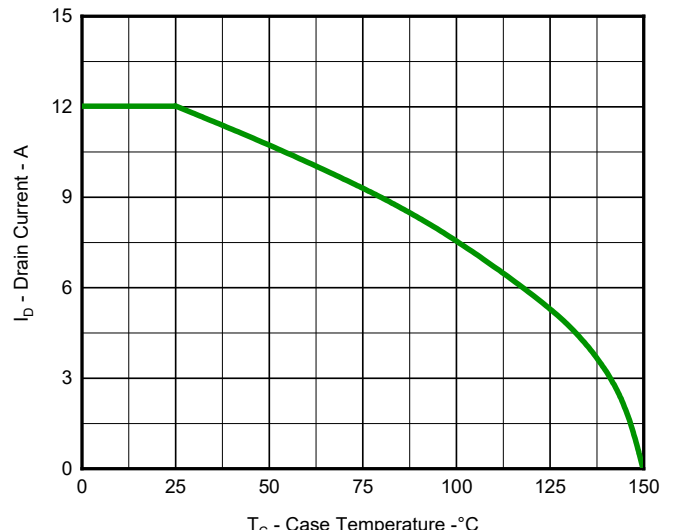

Fig.6 Maximum Drain Current vs. Case Temperature

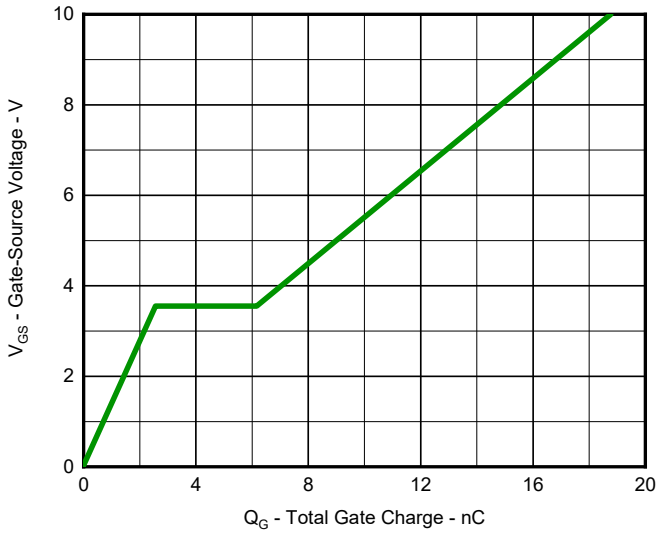

Fig.7 Gate Charge Characteristics

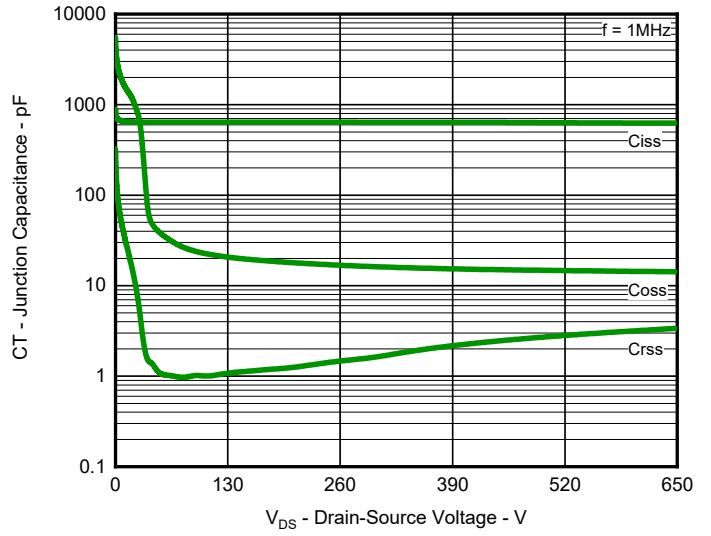

Fig.8 Typical Junction Capacitance

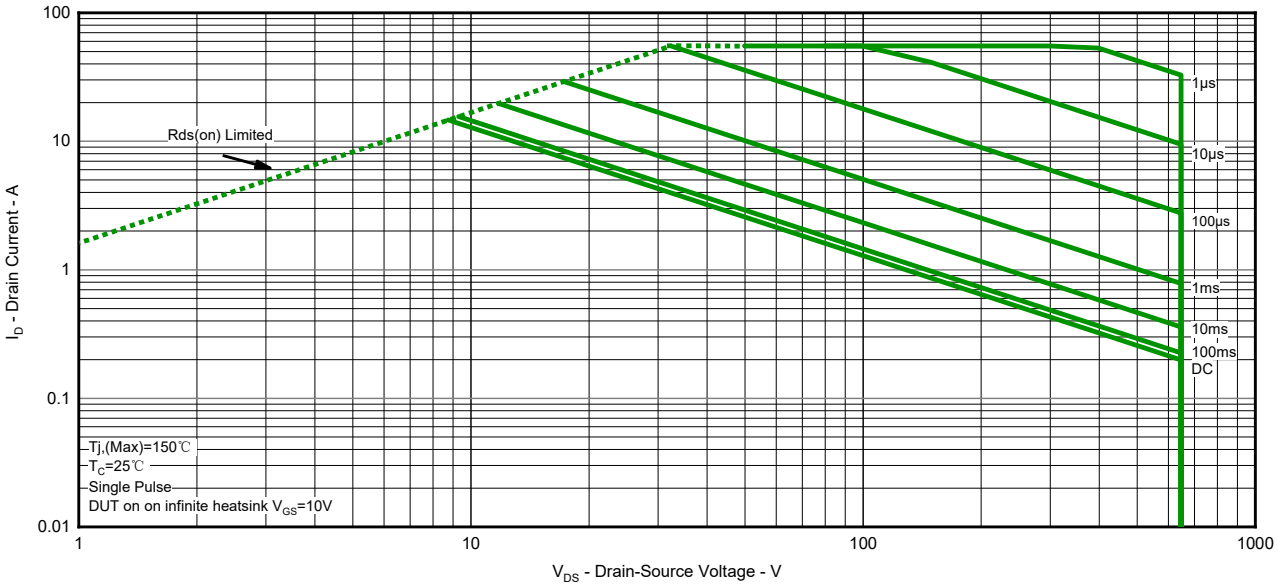

Fig.9 Safe Operation Area

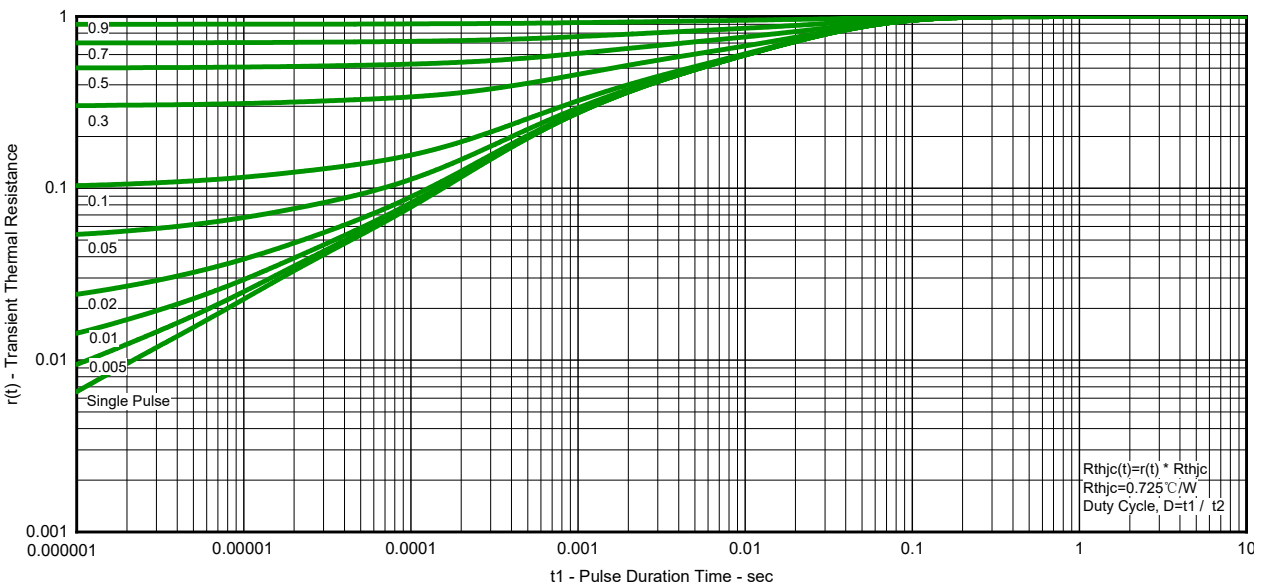
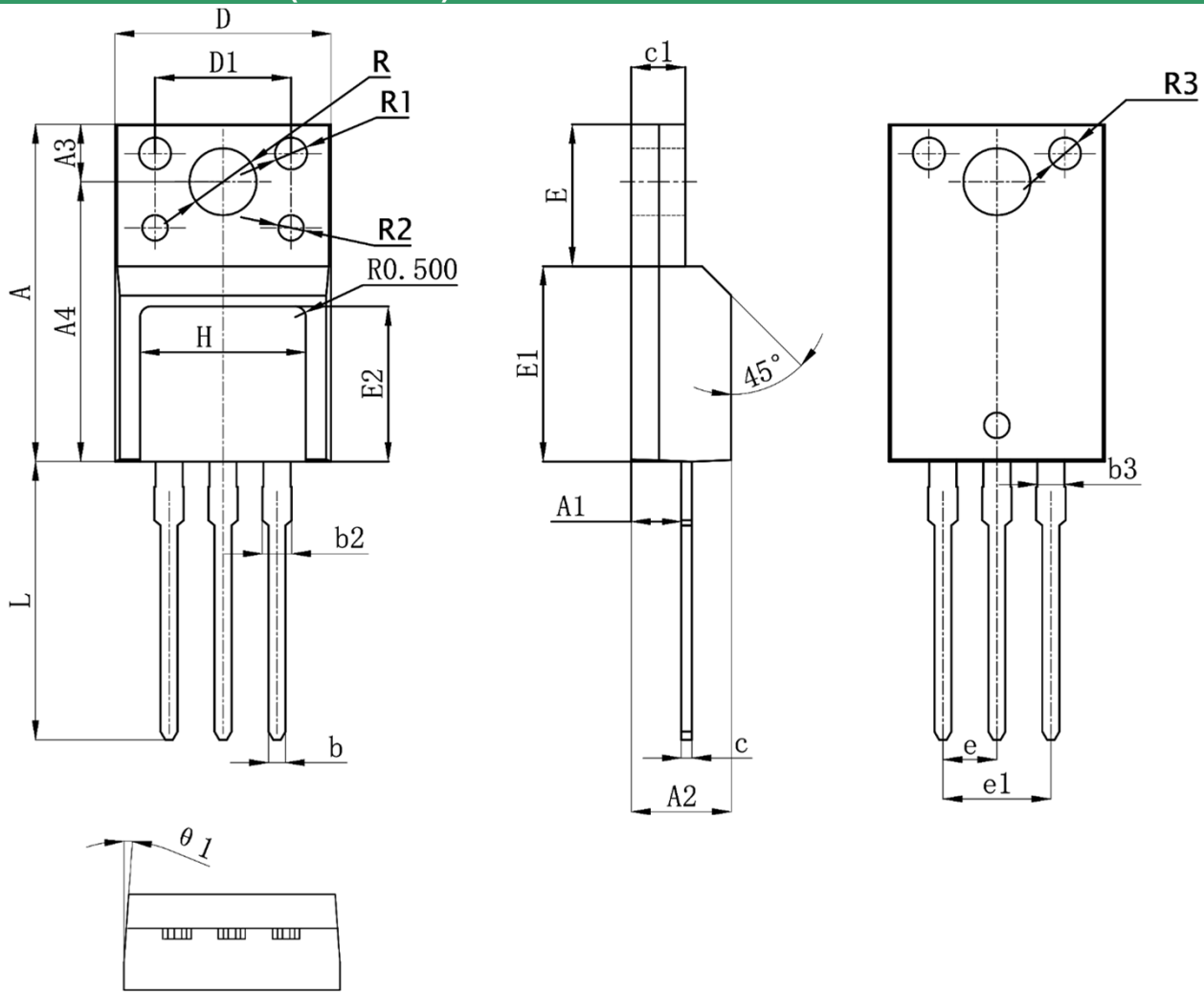



Fig.10 Transient Thermal Resistance

Product Dimension (TO-220F)



Dim	Millimeters		Inches		Dim	Millimeters		Inches	
	Min	Max	Min	Max		Min	Max	Min	Max
A	15.67	16.07	0.617	0.633	E	6.48	6.88	0.255	0.271
A1	2.15	2.55	0.085	0.100	E1	8.99	9.39	0.354	0.370
A2	4.50	4.90	0.177	0.193	E2	7.10	7.50	0.280	0.295
A3	3.10	3.50	0.122	0.138	e	2.54 BSC		0.100 BSC	
A4	12.27	12.87	0.483	0.507	e1	5.08 BSC		0.200 BSC	
b	0.77	0.83	0.030	0.033	L	13.14	13.54	0.517	0.533
b2	1.20	1.40	0.047	0.055	R	3.10	3.50	0.122	0.138
b3	1.20 BSC		0.047 BSC		R1	1.50 Ref.		0.059 Ref.	
c	0.40	0.60	0.016	0.024	R2	1.20 Ref.		0.047 Ref.	
c1	2.44	2.64	0.096	0.104	R3	1.50 Ref.		0.059 Ref.	
D	9.86	10.46	0.388	0.412	H	7.60	8.00	0.299	0.315
D1	6.90	7.10	0.272	0.280	θ_1	4°	5°	4°	5°

IMPORTANT NOTICE

 and **Prisemi**[®] are registered trademarks of **Prisemi Electronics Co., Ltd** (Prisemi), Prisemi reserves the right to make changes without further notice to any products herein. Prisemi makes no warranty, representation or guarantee regarding the suitability of its products for any particular purpose, nor does Prisemi assume any liability arising out of the application or use of any product or circuit, and specifically disclaims any and all liability, including without limitation special, consequential or incidental damages. "Typical" parameters which may be provided in Prisemi data sheets and/or specifications can and do vary in different applications and actual performance may vary over time. All operating parameters, including "Typicals" must be validated for each customer application by customer's technical experts. Prisemi does not convey any license under its patent rights nor the rights of others. The products listed in this document are designed to be used with ordinary electronic equipment or devices, Should you intend to use these products with equipment or devices which require an extremely high level of reliability and the malfunction of which would directly endanger human life (such as medical instruments, aerospace machinery, nuclear-reactor controllers, fuel controllers and other safety devices), please be sure to consult with our sales representative in advance.

Website: <http://www.prisemi.com>

For additional information, please contact your local Sales Representative.

©Copyright 2009, Prisemi Electronics

 **Prisemi**[®] is a registered trademark of Prisemi Electronics.

All rights are reserved.