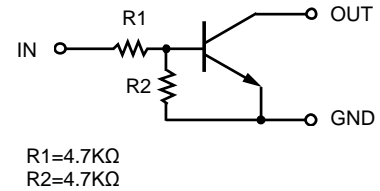

**Feature**

- Built-in bias resistors enable the configuration of an inverter circuit without connecting external input resistors (see equivalent circuit).
- The bias resistors consist of thin-film resistors with complete isolation to allow negative biasing of the input. They also have the advantage of almost completely eliminating parasitic effects.
- Only the on/off conditions need to be set for operation, making the device design easy.

**Applications**

- Inverter
- Interface
- Driver

**Mechanical Characteristics**

- Lead finish:100% matte Sn(Tin)
- Mounting position: Any
- Qualified max reflow temperature:260℃
- Device meets MSL 1 requirements
- Pure tin plating: 7 ~ 17 um
- Pin flatness :≤3mil

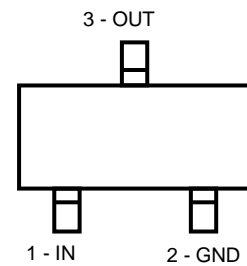

Top View

**Structure**

NPN epitaxial planar silicon transistor (Resistor built-in type)

**Electrical characteristics per line@25℃ ( unless otherwise specified)**

Parameter	Symbol	Conditions	Min.	Typ.	Max.	Units
Input voltage	$V_{I(off)}$	$V_{CC}=5V, I_o=100\mu A$	-	-	0.5	V
	$V_{I(on)}$	$V_o=0.3V, I_o=20mA$	3	-	-	V
Output voltage	$V_{O(off)}$	$I_o/I_i=10mA/0.5mA$	-	0.1	0.3	V
Input current	$I_i$	$V_i=5V$	-	-	1.8	mA
Output current	$I_{O(off)}$	$V_{CC}=50V, V_i=0V$	-	-	0.5	μA
DC current gain	$G_1$	$V_o=5V, I_o=10mA$	30	-	-	-
Input resistance	$R_1$	-	3.29	4.7	6.11	KΩ
Resistance ration	$R_2/R_1$	-	0.8	1.0	1.2	-
Transition frequency	$f_T$	$V_{CE}=10V, I_E=-5mA, f=100MHz$	-	250	-	MHz

Absolute maximum rating@25°C

Rating	Symbol	Value	Units
Supply voltage	$V_{CC}$	50	V
Input voltage	$V_{IN}$	-10 to +30	V
Output current	$I_o$	100	mA
	$I_{C(MAX.)}$	100	mA
Power dissipation	$P_d$	150	mW
Junction temperature	$T_j$	150	°C
Storage temperature	$T_{stg}$	-55 to +150	°C

Typical Characteristics

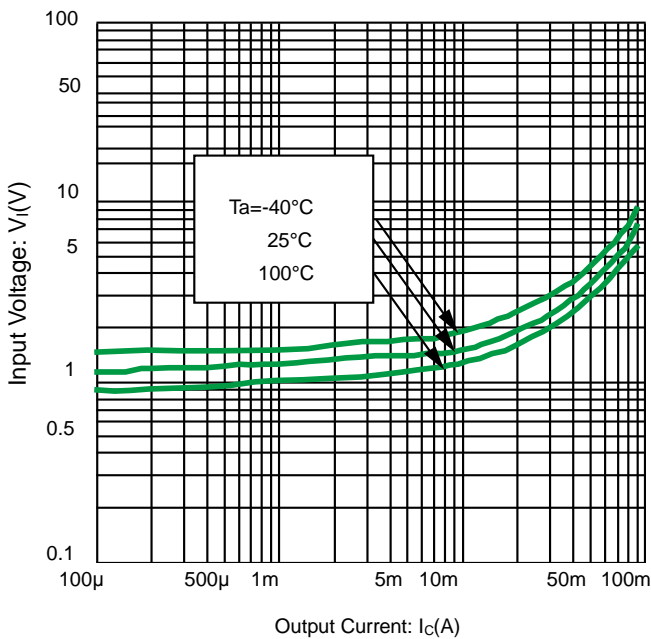

Fig 1. Input Voltage vs. output current  
@  $V_C=0.3V$  (ON characteristics)

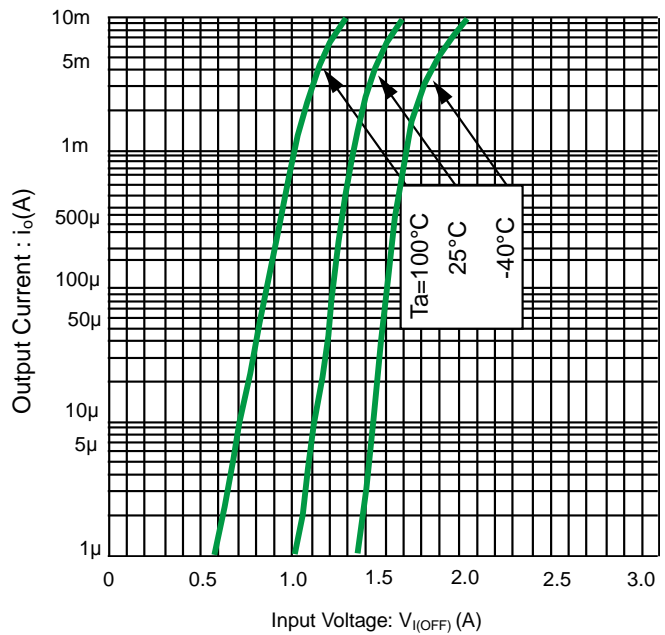
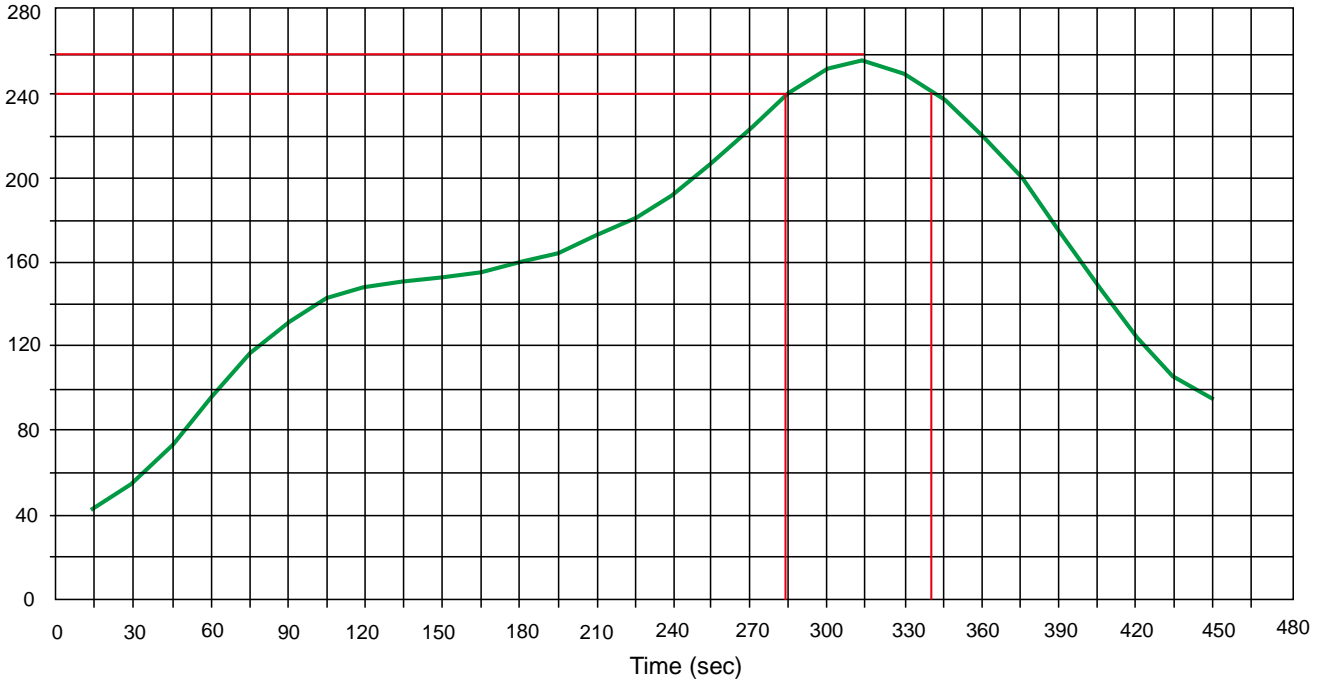

Fig 2. Output current vs. input voltage  
@  $V_{CC}=5V$  (OFF characteristics)

**Solder Reflow Recommendation**

Peak Temp=257°C, Ramp Rate=0.802deg. °C/sec



**Product dimension (SOT-523)**

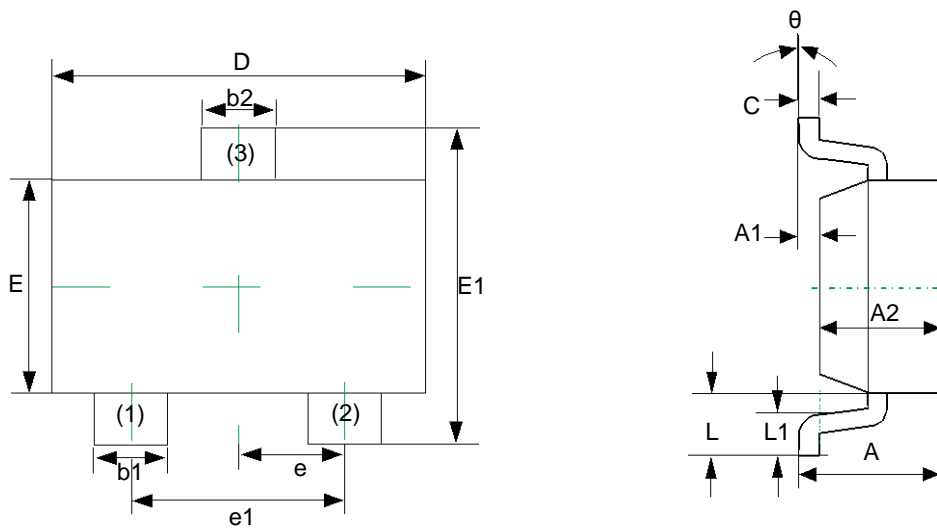

Dim	Millimeters		Inches	
	MIN	MAX	MIN	MAX
A	0.700	0.900	0.028	0.035
A1	0.000	0.100	0.000	0.004
A2	0.700	0.800	0.028	0.031
b1	0.150	0.250	0.006	0.010
b2	0.250	0.350	0.010	0.014
c	0.100	0.200	0.004	0.008
D	1.500	1.700	0.059	0.067
E	0.700	0.900	0.028	0.035
E1	1.450	1.750	0.057	0.069
e	0.500TYP		0.020TYP	
e1	0.900	1.100	0.035	0.043
L	0.400REF		0.016REF	
L1	0.260	0.460	0.010	0.018
$\theta$	0°		8°	

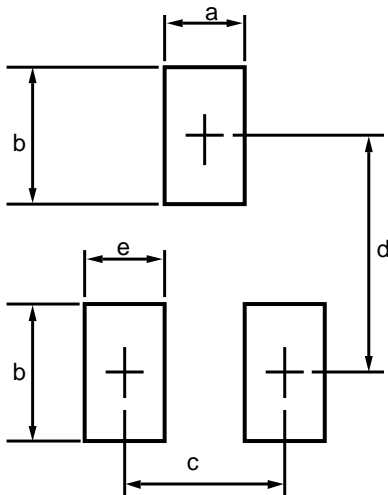

Dim	Millimeters	
	MIN	MAX
a	--	0.5
b	--	0.6
c	--	1.0
d	--	1.24
e	--	0.4

Ordering information

Device	Package	Shipping
PDTC143EE	SOT-523 (Pb-Free)	3000 / Tape & Reel

**IMPORTANT NOTICE**

 and **Prisemi**<sup>®</sup> are registered trademarks of **Prisemi Electronics Co., Ltd (Prisemi)** ,Prisemi reserves the right to make changes without further notice to any products herein. Prisemi makes no warranty, representation or guarantee regarding the suitability of its products for any particular purpose, nor does Prisemi assume any liability arising out of the application or use of any product or circuit, and specifically disclaims any and all liability, including without limitation special, consequential or incidental damages. “Typical” parameters which may be provided in Prisemi data sheets and/or specifications can and do vary in different applications and actual performance may vary over time. All operating parameters, including “Typicals” must be validated for each customer application by customer’s technical experts. Prisemi does not convey any license under its patent rights nor the rights of others. The products listed in this document are designed to be used with ordinary electronic equipment or devices, Should you intend to use these products with equipment or devices which require an extremely high level of reliability and the malfunction of with would directly endanger human life (such as medical instruments, aerospace machinery, nuclear-reactor controllers, fuel controllers and other safety devices), please be sure to consult with our sales representative in advance.

Website: <http://www.prisemi.com>

For additional information, please contact your local Sales Representative.

©Copyright 2009, Prisemi Electronics

 **Prisemi**<sup>®</sup> is a registered trademark of Prisemi Electronics.

All rights are reserved.