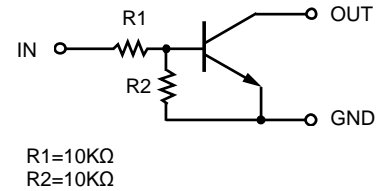

Feature

- Built-in bias resistors enable the configuration of an inverter circuit without connecting external input resistors (see equivalent circuit).
- The bias resistors consist of thin-film resistors with complete isolation to allow negative biasing of the input. They also have the advantage of almost completely eliminating parasitic effects.
- Only the on/off conditions need to be set for operation, making the device design easy.

Applications

- Inverter
- Interface
- Driver

Mechanical Characteristics

- Lead finish:100% matte Sn(Tin)
- Mounting position: Any
- Qualified max reflow temperature:260℃
- Device meets MSL 1 requirements
- Pure tin plating: 7 ~ 17 um
- Pin flatness :≤3mil

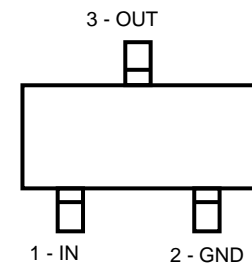

Top View

Structure

NPN epitaxial planar silicon transistor (Resistor built-in type)

Electrical characteristics per line@25℃ (unless otherwise specified)

Parameter	Symbol	Conditions	Min.	Typ.	Max.	Units
Input voltage	$V_{I(off)}$	$V_{CC}=5V, I_O=100\mu A$	-	-	0.5	V
	$V_{I(on)}$	$V_O=0.3V, I_O=10mA$	3	-	-	V
Output voltage	$V_{O(off)}$	$I_O/I_I=10mA/0.5mA$	-	0.1	0.3	V
Input current	I_I	$V_I=5V$	-	-	0.88	mA
Output current	$I_{O(off)}$	$V_{CC}=50V, V_I=0V$	-	-	0.5	μA
DC current gain	G_1	$V_O=5V, I_O=5mA$	30	-	-	-
Input resistance	R_1	-	7	10	13	KΩ
Resistance ration	R_2/R_1	-	0.8	1	1.2	-
Transition frequency	f_T	$V_{CE}=10V, I_E=-5mA, f=100MHz$	-	250	-	MHz

Absolute maximum rating@25°C

Rating	Symbol	Value	Units
Supply voltage	V_{CC}	50	V
Input voltage	V_{IN}	-10 to +40	V
Output current	I_o	50	mA
	$I_{C(MAX.)}$	100	mA
Power dissipation	P_d	150	mW
Junction temperature	T_j	150	°C
Storage temperature	T_{stg}	-55 to +150	°C

Typical Characteristics

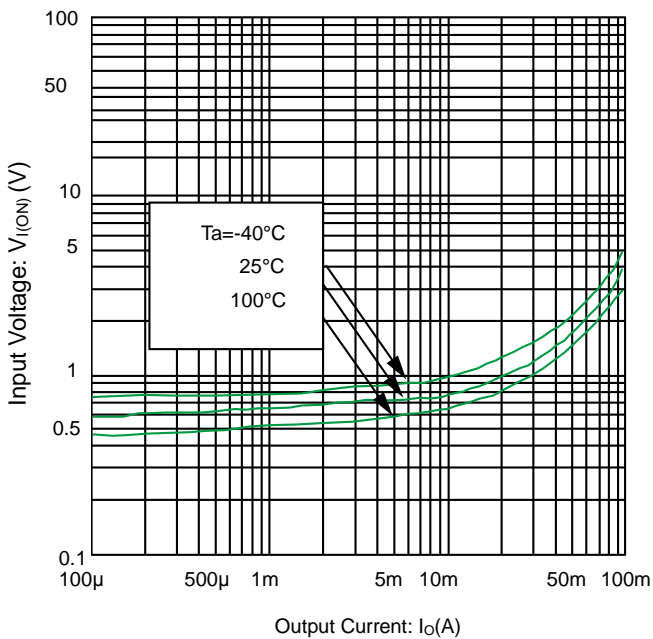

Fig 1. Input Voltage vs. output current
@ $V_C=0.3V$ (ON characteristics)

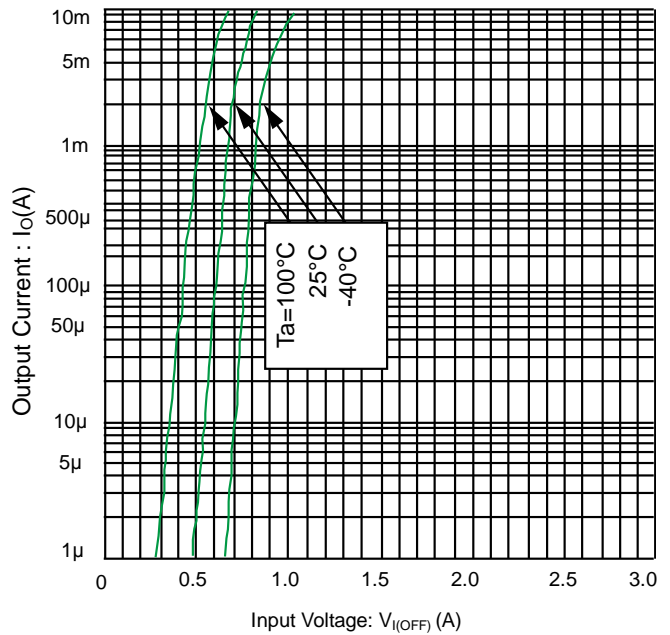
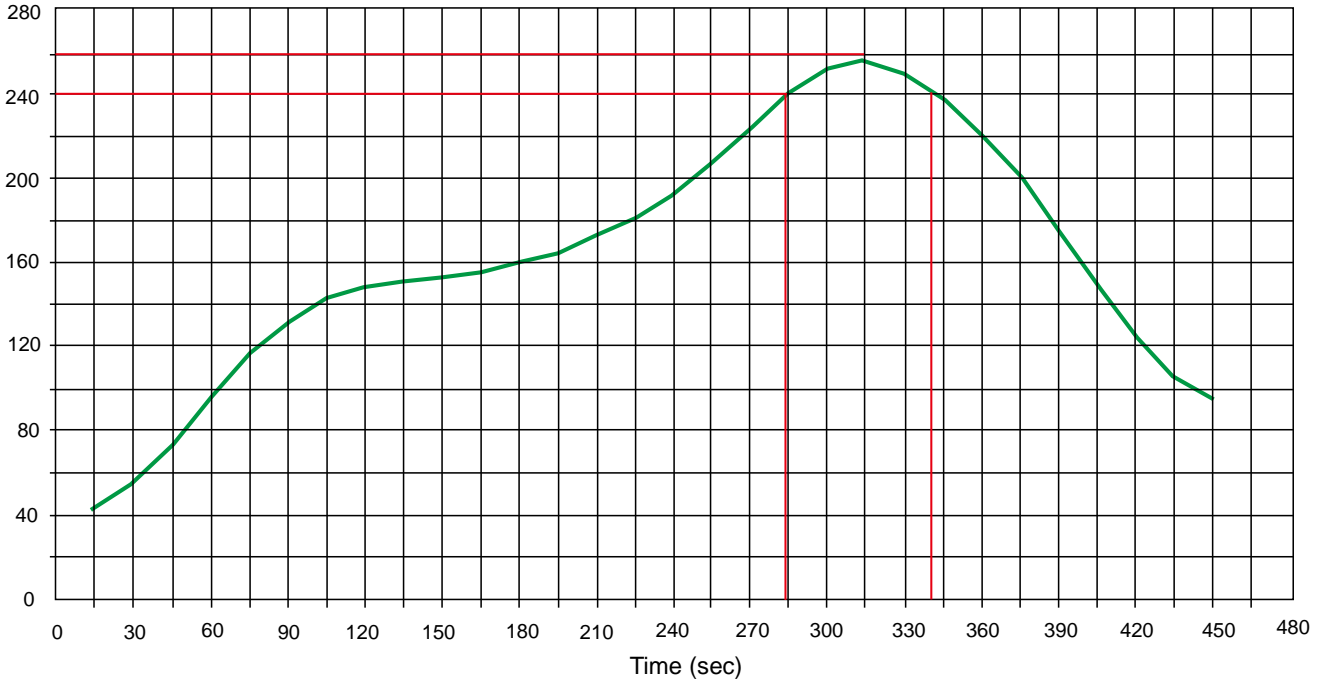

Fig 2. Output current vs. input voltage
@ $V_{CC}=5V$ (OFF characteristics)

Solder Reflow Recommendation

Peak Temp=257°C, Ramp Rate=0.802deg. °C/sec



Product dimension (SOT-523)

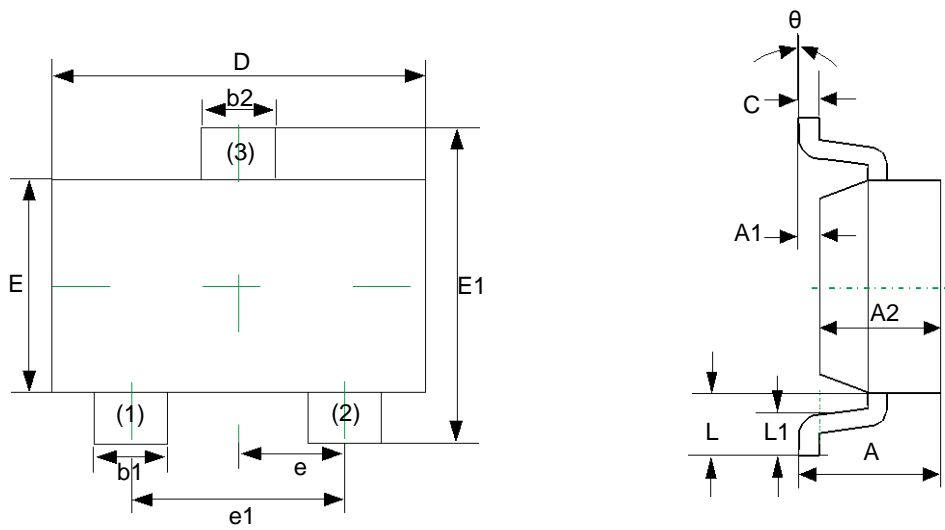

Dim	Millimeters		Inches	
	MIN	MAX	MIN	MAX
A	0.700	0.900	0.028	0.035
A1	0.000	0.100	0.000	0.004
A2	0.700	0.800	0.028	0.031
b1	0.150	0.250	0.006	0.010
b2	0.250	0.350	0.010	0.014
c	0.100	0.200	0.004	0.008
D	1.500	1.700	0.059	0.067
E	0.700	0.900	0.028	0.035
E1	1.450	1.750	0.057	0.069
e	0.500TYP		0.020TYP	
e1	0.900	1.100	0.035	0.043
L	0.400REF		0.016REF	
L1	0.260	0.460	0.010	0.018
θ	0°	8°	0°	8°

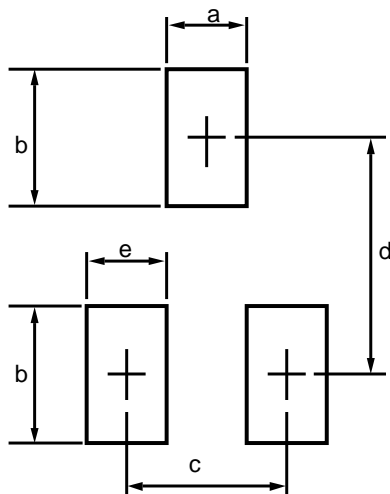

Dim	Millimeters	
	MIN	MAX
a	--	0.5
b	--	0.6
c	--	1.0
d	--	1.24
e	--	0.4

Ordering information

Device	Package	Shipping
PDTC114EE	SOT-523 (Pb-Free)	3000 / Tape & Reel

IMPORTANT NOTICE

 and **Prisemi**[®] are registered trademarks of **Prisemi Electronics Co., Ltd (Prisemi)** ,Prisemi reserves the right to make changes without further notice to any products herein. Prisemi makes no warranty, representation or guarantee regarding the suitability of its products for any particular purpose, nor does Prisemi assume any liability arising out of the application or use of any product or circuit, and specifically disclaims any and all liability, including without limitation special, consequential or incidental damages. “Typical” parameters which may be provided in Prisemi data sheets and/or specifications can and do vary in different applications and actual performance may vary over time. All operating parameters, including “Typicals” must be validated for each customer application by customer’s technical experts. Prisemi does not convey any license under its patent rights nor the rights of others. The products listed in this document are designed to be used with ordinary electronic equipment or devices, Should you intend to use these products with equipment or devices which require an extremely high level of reliability and the malfunction of with would directly endanger human life (such as medical instruments, aerospace machinery, nuclear-reactor controllers, fuel controllers and other safety devices), please be sure to consult with our sales representative in advance.

Website: <http://www.prisemi.com>

For additional information, please contact your local Sales Representative.

©Copyright 2009, Prisemi Electronics

 **Prisemi**[®] is a registered trademark of Prisemi Electronics.

All rights are reserved.