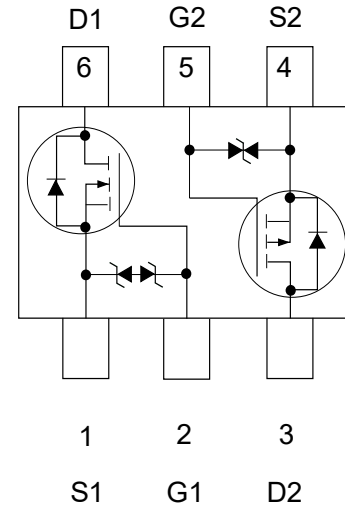

Description

The enhancement mode MOS is extremely high density cell and low on-resistance.

MOSFET Product Summary		
$V_{DS}(V)$	$R_{DS(on)}(\Omega)$	$I_D(A)$
N-Channel 20	0.2@ $V_{GS}=4.5V$	0.8
	0.25@ $V_{GS}=2.5V$	
	0.31@ $V_{GS}=1.8V$	
P-Channel -20	0.45@ $V_{GS}=-4.5V$	-0.8
	0.62@ $V_{GS}=-2.5V$	
	0.86@ $V_{GS}=-1.8V$	

Thermal resistance ratings

Parameter	Symbol	Typical	Maximum	Units
Thermal Resistance-Junction to Ambient, Note:a	$R_{\theta JA}$	340	430	$^{\circ}C/W$
Thermal Resistance-Junction to Ambient, Note:b	$R_{\theta JA}$	465	555	$^{\circ}C/W$
Thermal Resistance-Junction to Case	$R_{\theta JC}$	280	320	$^{\circ}C/W$

a: Surface mounted on FR4 Board using 1 square inch pad size, 1oz copper

b: Surface mounted on FR4 Board using minimum pad size, 1oz copper

N-Channel
Absolute maximum rating@25°C

Rating		Symbol	Value	Units
Drain-Source Voltage		V_{DS}	20	V
Gate-Source Voltage		V_{GS}	± 8	V
Drain Current	Continuous	I_D	0.8	A
	Pulsed	I_D	3.0	A
Total Power Dissipation	$T_A=25^{\circ}C$, Note:a	P_D	290	mW
	$T_A=25^{\circ}C$, Note:b	P_D	220	mW

Electrical characteristics per line@25°C (unless otherwise specified)

Parameter	Symbol	Conditions	Min.	Typ.	Max.	Units
Drain-Source Breakdown Voltage	BV_{DSS}	$I_D=1mA, V_{GS}=0V$	20	-	-	V
Zero Gate Voltage Drain Current	I_{DSS}	$V_{DS}=20V, V_{GS}=0V$	-	-	1	μA
Gate-Body Leakage Current	I_{GSS}	$V_{DS}=0V, V_{GS}=\pm 8V$	-	-	± 10	μA
Gate Threshold Voltage	$V_{GS(th)}$	$V_{DS}=10V, I_D=1mA$	0.4	-	0.8	V
Static Drain-Source On-Resistance	$R_{DS(on)}$	$V_{GS}=4.5V, I_D=0.65A$	-	200	250	$m\Omega$
		$V_{GS}=2.5V, I_D=0.45A$	-	250	300	$m\Omega$
		$V_{GS}=1.8V, I_D=0.25A$	-	310	450	$m\Omega$
Forward transfer admittance	g_{FS}	$V_{DS}=10V, I_D=300mA$	-	1.6	-	s
Input Capacitance	C_{ISS}	$V_{GS}=0V, V_{DS}=10V, f=1MHz$	-	48	-	pF
Output Capacitance	C_{OSS}		-	13	-	pF
Reverse Transfer Capacitance	C_{RSS}		-	10	-	pF
Total Gate Charge	Q_G	$V_{GS}=4.5V, V_{DS}=10V, I_D=0.01A$	-	1.0	-	nC
Gate-Source Charge	Q_{GS}		-	0.1	-	nC
Gate-Drain Charge	Q_{GD}		-	0.42	-	nC
Turn-On Delay Time	$t_{d(on)}$	$V_{DD}=10V, V_{GS}=4.0V, R_G=10\Omega, R_L=67\Omega, I_D=150mA$	-	12	-	ns
Turn-Off Delay Time	$t_{d(off)}$		-	50	-	ns
Turn-On Rise Time	t_r		-	13	-	ns
Turn-On Fall Time	t_f		-	25	-	ns
Drain-Source Diode Forward Voltage	V_{SD}	$V_{GS}=0V, I_S=100mA$	-	0.7	1	V

P-Channel

Absolute maximum rating@25°C

Rating	Symbol	Value	Units
Drain-Source Voltage	V_{DS}	-20	V
Gate-Source Voltage	V_{GS}	± 8	V
Drain Current	Continuous	-0.8	A
	Pulsed	-3	A
Total Power Dissipation	$T_A=25^\circ C, \text{Note:a}$	290	mW
	$T_A=25^\circ C, \text{Note:b}$	220	mW

Electrical characteristics per line @ 25 °C (unless otherwise specified)

Parameter	Symbol	Conditions	Min.	Typ.	Max.	Units
OFF CHARACTERISTICS						
Drain-to-Source Breakdown Voltage	BV_{DSS}	$I_D = -250\mu A, V_{GS} = 0V$	-20	-	-	V
Zero Gate Voltage Drain Current	I_{DSS}	$V_{DS} = -16V, V_{GS} = 0V$	-	-	-1	μA
Gate-to-source Leakage Current	I_{GSS}	$V_{DS} = 0V, V_{GS} = \pm 8V$	-	-	± 10	μA
ON CHARACTERISTICS						
Gate Threshold Voltage	$V_{GS(th)}$	$V_{GS} = V_{DS}, I_D = -250\mu A$	-0.45	-0.55	-0.85	V
Drain-to-source On-resistance (Note 5)	$R_{DS(on)}$	$V_{GS} = -4.5V, I_D = -700mA$	-	450	700	$m\Omega$
		$V_{GS} = -2.5V, I_D = -300mA$	-	620	850	$m\Omega$
		$V_{GS} = -1.8V, I_D = -250mA$	-	860	1200	$m\Omega$
Forward Transconductance	g_{FS}	$V_{DS} = -5V, I_D = -450mA$	-	1.25	-	S
CHARGES, CAPACITANCES AND GATE RESISTANCE						
Input Capacitance	C_{ISS}	$V_{GS} = 0V, V_{DS} = -10V,$ $f = 1MHz$	-	72	-	pF
Output Capacitance	C_{OSS}		-	9.5	-	pF
Reverse Transfer Capacitance	C_{RSS}		-	9.8	-	pF
Total Gate Charge	$Q_{G(TOT)}$	$V_{GS} = -4.5V, V_{DS} = -10V,$ $I_D = -450mA$	-	0.9	-	nC
Threshold Gate Charge	$Q_{G(TH)}$		-	0.1	-	nC
Gate-to-Source Charge	Q_{GS}		-	0.15	-	nC
Gate-to-Drain Charge	Q_{GD}		-	0.3	-	nC
SWITCHING CHARACTERISTICS						
Turn-On Delay Time	$t_d(ON)$	$V_{GS} = -4.5V, V_{DS} = -10V,$ $I_D = -450mA$ $R_G = 6\Omega$	-	43	-	nS
Rise Time	t_r		-	137	-	nS
Turn-Off Delay Time	$t_d(OFF)$		-	1450	-	nS
Fall Time	t_f		-	2050	-	nS
BODY DIODE CHARACTERISTICS						
Forward Voltage	V_{SD}	$V_{GS} = 0V, I_S = -150mA$	-0.5	-0.65	-1.1	V

N-Channel

Typical Characteristics

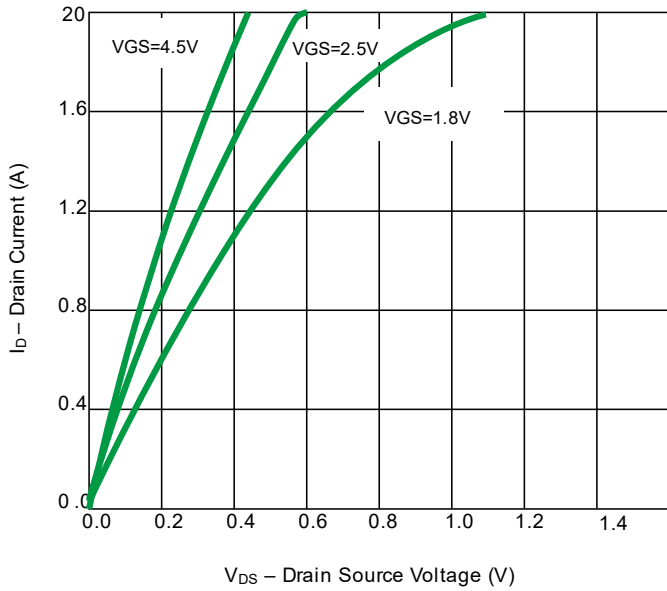

Fig 1. Output Characteristics

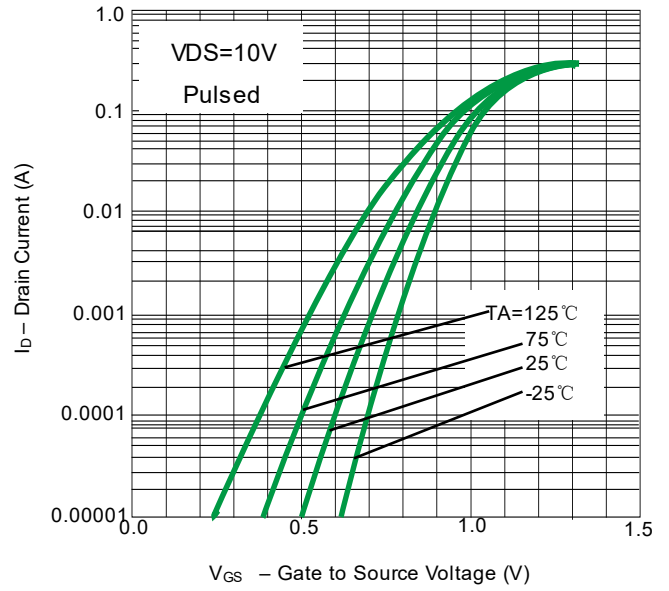

Fig 2. Transfer Characteristics

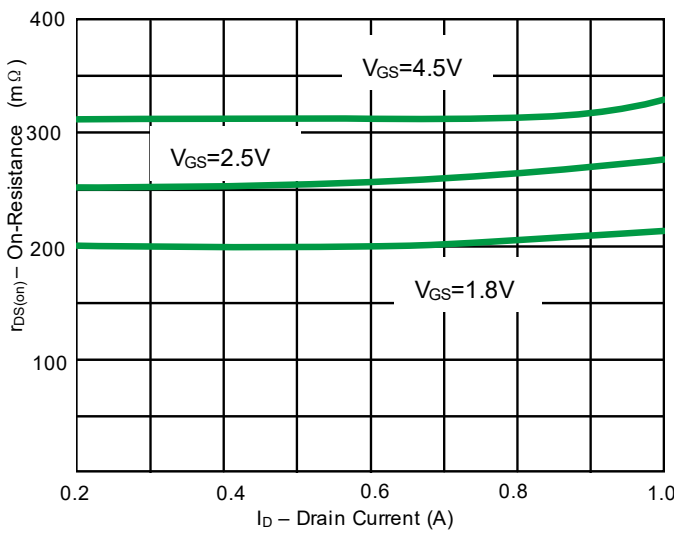

Fig 3. On-Resistance vs. Drain Current

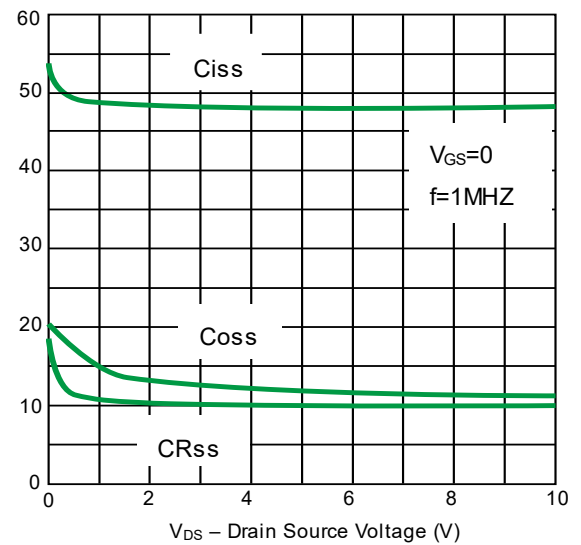

Fig 4. Capacitance

P-Channel

Typical Characteristics

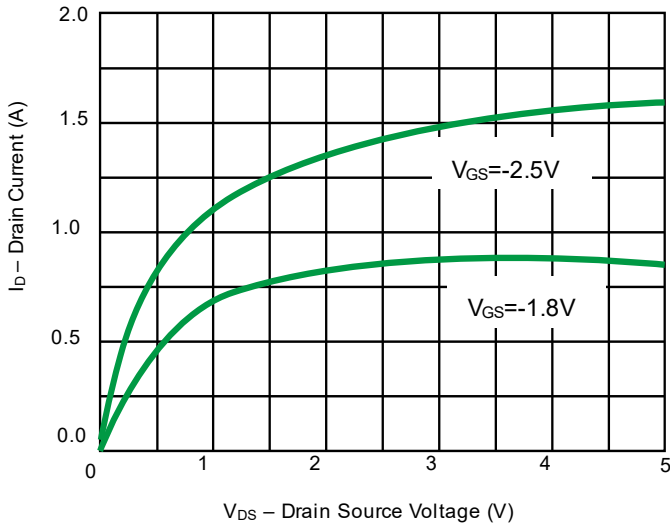

Fig 1. Output Characteristics

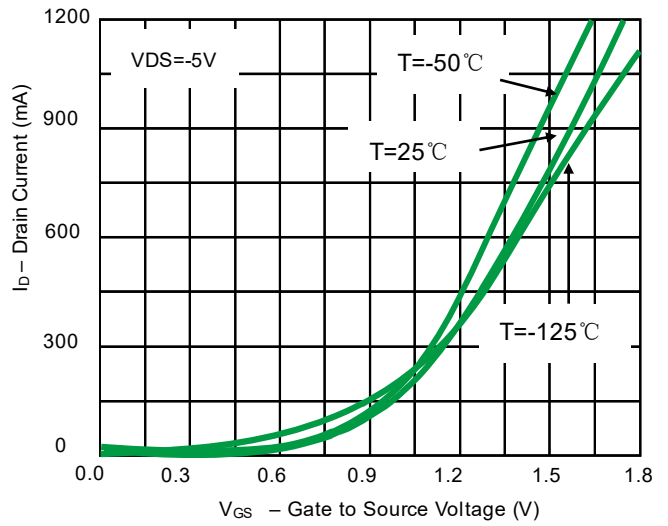

Fig 2. Transfer Characteristics

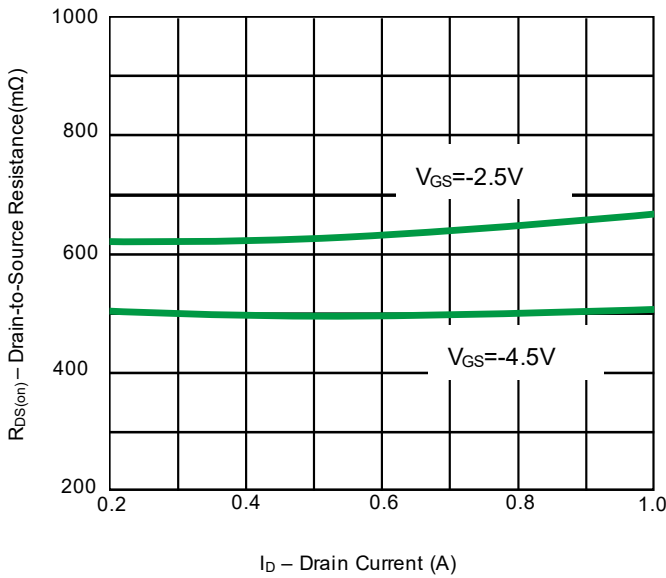

Fig 3. On-Resistance vs. Drain Current

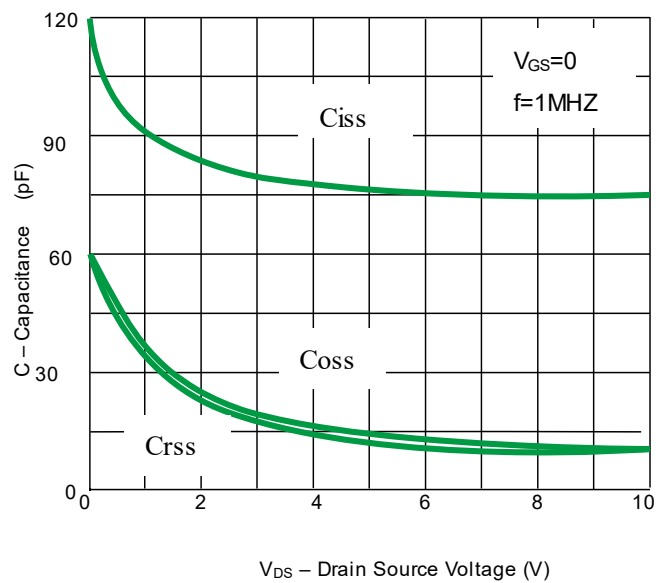
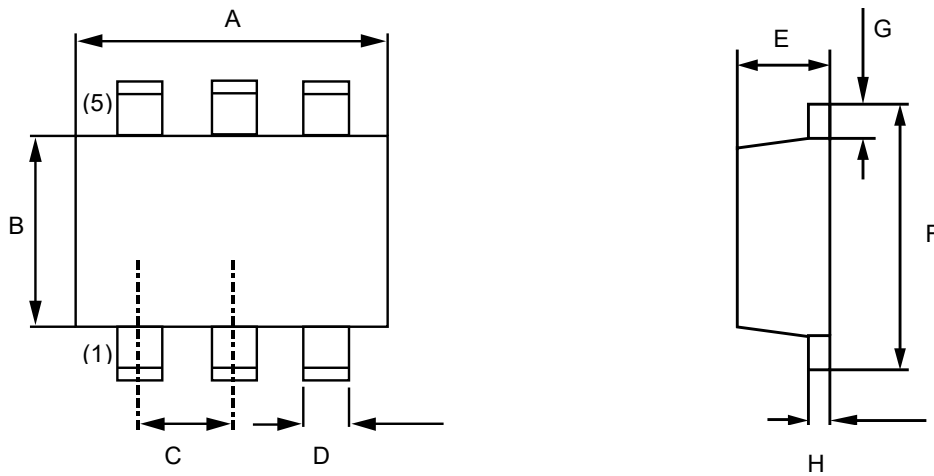
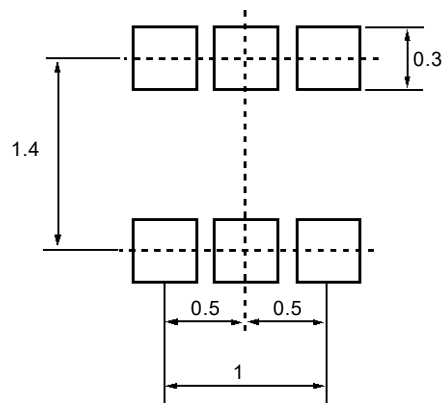

Fig 4. Capacitance

Product dimension (SOT-563)



Dim	Millimeters		Inches	
	MIN	MAX	MIN	MAX
A	1.50	1.70	0.059	0.067
B	1.10	1.30	0.043	0.051
C	0.50BSC		0.020BSC	
D	0.17	0.27	0.007	0.011
E	0.50	0.60	0.020	0.024
F	1.50	1.70	0.059	0.067
G	0.10	0.30	0.004	0.012
H	0.08	0.16	0.003	0.006



Ordering information

Device	Package	Shipping
PDM6ET20V08E	SOT-563 (Pb-Free)	3000 / Tape & Reel

IMPORTANT NOTICE

 and **Prisemi**[®] are registered trademarks of **Prisemi Electronics Co., Ltd** (Prisemi) ,Prisemi reserves the right to make changes without further notice to any products herein. Prisemi makes no warranty, representation or guarantee regarding the suitability of its products for any particular purpose, nor does Prisemi assume any liability arising out of the application or use of any product or circuit, and specifically disclaims any and all liability, including without limitation special, consequential or incidental damages. “Typical” parameters which may be provided in Prisemi data sheets and/or specifications can and do vary in different applications and actual performance may vary over time. All operating parameters, including “Typicals” must be validated for each customer application by customer’s technical experts. Prisemi does not convey any license under its patent rights nor the rights of others. The products listed in this document are designed to be used with ordinary electronic equipment or devices, Should you intend to use these products with equipment or devices which require an extremely high level of reliability and the malfunction of with would directly endanger human life (such as medical instruments, aerospace machinery, nuclear-reactor controllers, fuel controllers and other safety devices), please be sure to consult with our sales representative in advance.

Website: <http://www.prisemi.com>

For additional information, please contact your local Sales Representative.

©Copyright 2009, Prisemi Electronics

 **Prisemi**[®] is a registered trademark of Prisemi Electronics.

All rights are reserved.