

Description

The PESDNC2ND5VB protects sensitive semiconductor components from damage or upset due to electrostatic discharge (ESD) and other voltage induced transient events. They feature large cross-sectional area junctions for conducting high transient currents, offer desirable electrical characteristics for board level protection, such as fast response time, low operating voltage. It gives designer the flexibility to protect one bi-directional line in applications where arrays are not practical.

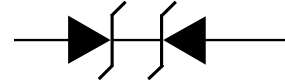

Feature

- 80W peak pulse power per line ($t_P = 8/20\mu s$)
- WBFBP-2 package
- Replacement for MLV(0402)
- Unidirectional or Bidirectional configurations
- Response Time is Typically $< 1ns$
- ESD protection $> 15kV$
- Low clamping voltage
- RoHS compliant
- Transient protection for data lines to IEC61000-4-2(ESD) $\pm 30kV$ (air), $\pm 30kV$ (contact); IEC61000-4-4 (EFT) 40A (5/50ns)

Applications

- Cellular phones
- Portable devices
- Digital cameras
- Power supplies

Mechanical Characteristics

- Lead finish:100% matte Sn(Tin)
- Mounting position: Any
- Qualified max reflow temperature:260°C
- Device meets MSL 1 requirements
- Pure tin plating: 7 ~ 17 μm
- Pin flatness: $\leq 3mil$

Electronics Parameter

Symbol	Parameter
V_{RWM}	Peak Reverse Working Voltage
I_R	Reverse Leakage Current @ V_{RWM}
V_{BR}	Breakdown Voltage @ I_T
I_T	Test Current
I_{PP}	Maximum Reverse Peak Pulse Current
V_C	Clamping Voltage @ I_{PP}
P_{PP}	Peak Pulse Power
C_J	Junction Capacitance
I_F	Forward Current
V_F	Forward Voltage @ I_F

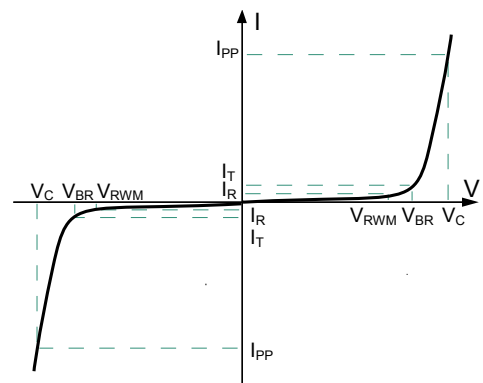

Electrical characteristics per line@25°C (unless otherwise specified)

Parameter	Symbol	Conditions	Min.	Typ.	Max.	Units
Reverse Stand-off Voltage	V_{RWM}				5	V
Reverse Breakdown Voltage	V_{BR}	$I_t = 1mA$	5.6	6.7	7.8	V
Reverse Leakage Current	I_R	$V_{RWM} = 5V T=25^{\circ}C$			1.0	μA
Junction Capacitance	C_j	$V_R=0V f = 1MHz$		15		pF

Absolute maximum rating@25°C

Rating	Symbol	Value	Units
Unidirectional Peak Pulse Power	P_{pp}	80	W
Operating Temperature	T_J	-55 to +150	$^{\circ}C$
Storage Temperature	T_{STG}	-55 to +150	$^{\circ}C$

Typical Characteristics

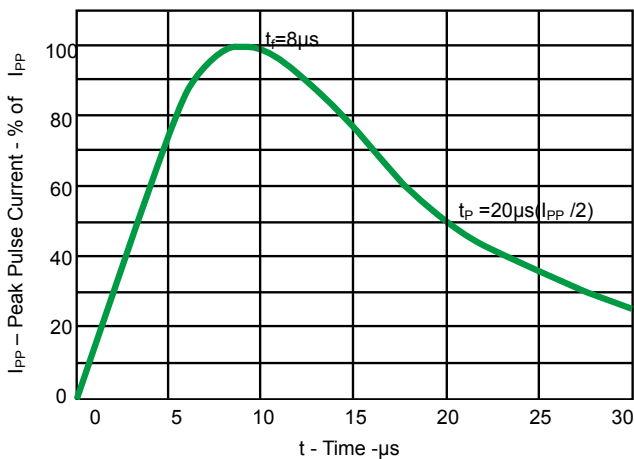

Fig 1.Pulse Waveform

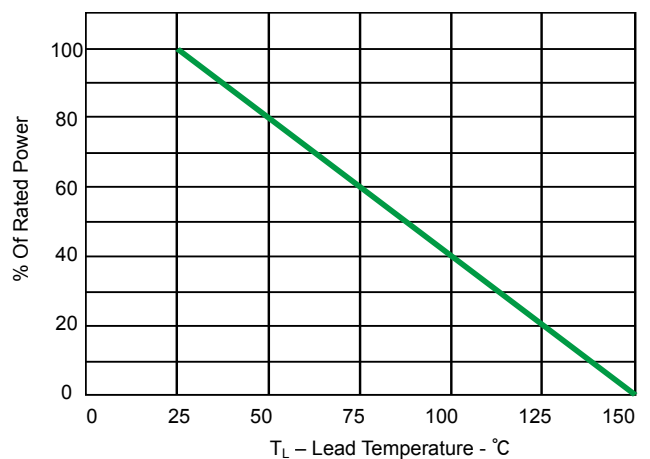

Fig 2.Power Derating Curve

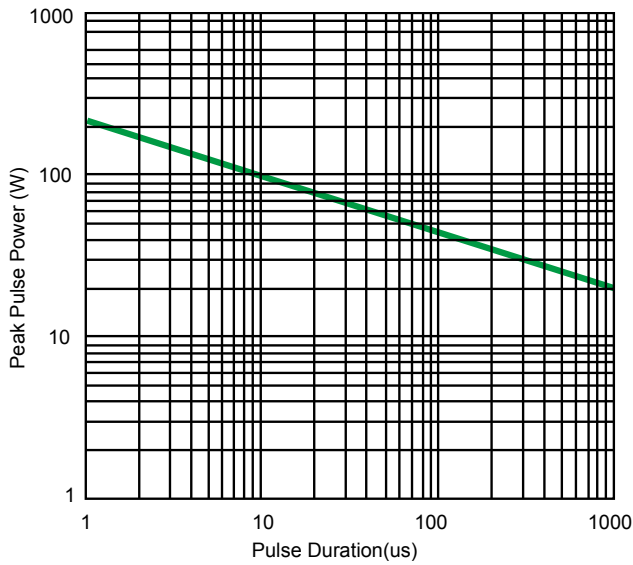
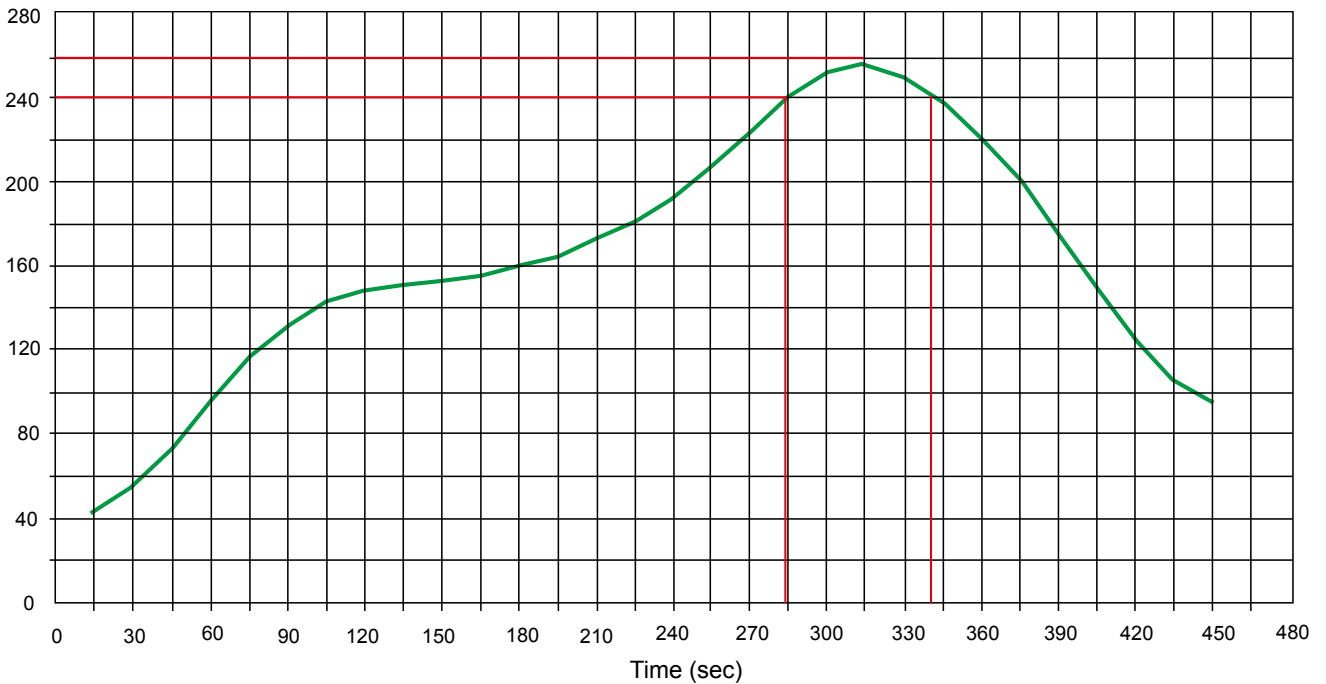

Fig 3. Non Repetitive Peak Pulse Power vs. Pulse time

Solder Reflow Recommendation

Peak Temp=257°C, Ramp Rate=0.802deg. °C/sec



PCB Design

For TVS diodes a low-ohmic and low-inductive path to chassis earth is absolutely mandatory in order to achieve good ESD protection. Novices in the area of ESD protection should take following suggestions to heart:

- Do not use stubs, but place the cathode of the TVS diode directly on the signal trace.
- Do not make false economies and save copper for the ground connection.
- Place via holes to ground as close as possible to the anode of the TVS diode.
- Use as many via holes as possible for the ground connection.
- Keep the length of via holes in mind! The longer the more inductance they will have.

Product dimension (WBFBP-02C)

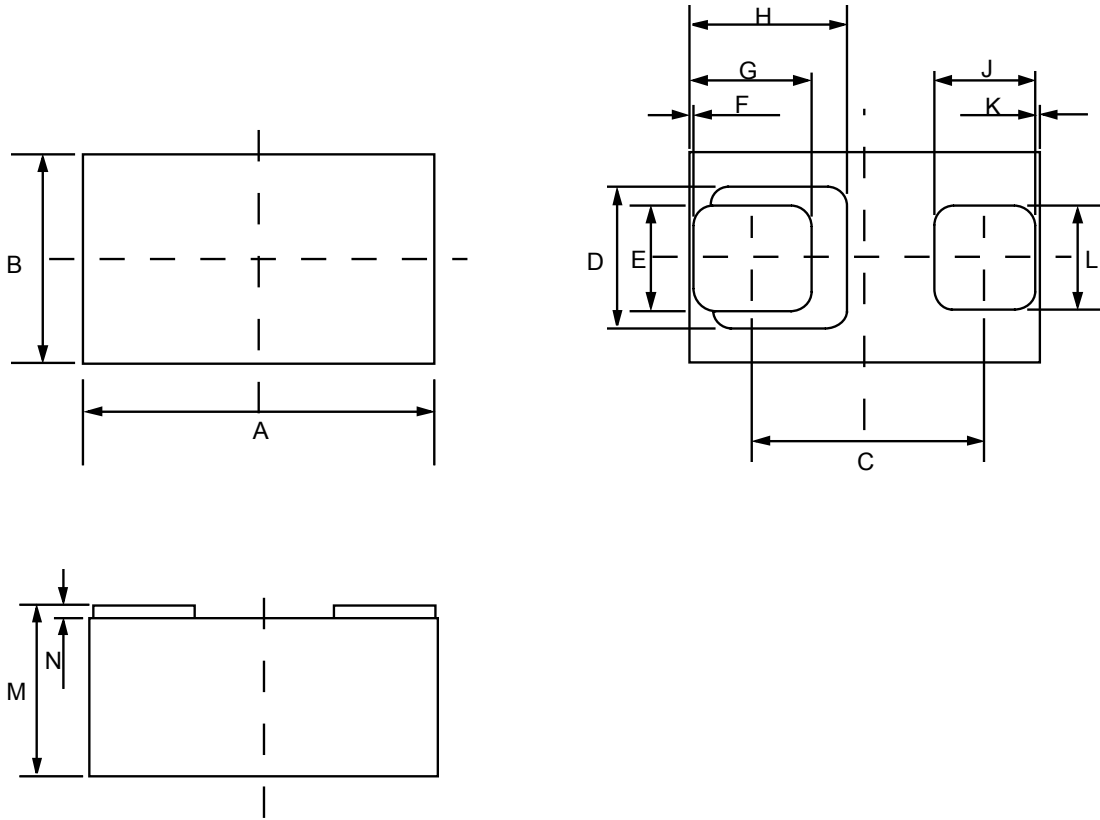

Dim	Millimeters		Inches	
	MIN	MAX	MIN	MAX
A	0.950	1.050	0.037	0.041
B	0.550	0.650	0.022	0.026
C	0.600	0.750	0.024	0.030
D	0.400REF		0.016REF	
E	0.250	0.350	0.010	0.014
F	0.010REF		0.000REF	
G	0.320	0.450	0.013	0.018
H	0.450REF		0.017REF	
J	0.250	0.350	0.010	0.014
K	0.010REF		0.000REF	
L	0.250	0.350	0.010	0.014
M	0.450	0.550	0.018	0.022
N	0.010	0.090	0.000	0.004

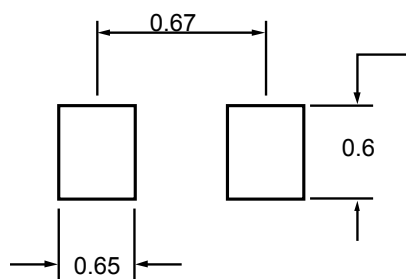
**Ordering information**

Device	Package	Shipping
PESDNC2ND5VB	WBFBP-02C (Pb-Free)	5000 / Tape & Reel

IMPORTANT NOTICE

 and **Prisemi**[®] are registered trademarks of **Prisemi Electronics Co., Ltd (Prisemi)** ,Prisemi reserves the right to make changes without further notice to any products herein. Prisemi makes no warranty, representation or guarantee regarding the suitability of its products for any particular purpose, nor does Prisemi assume any liability arising out of the application or use of any product or circuit, and specifically disclaims any and all liability, including without limitation special, consequential or incidental damages. "Typical" parameters which may be provided in Prisemi data sheets and/or specifications can and do vary in different applications and actual performance may vary over time. All operating parameters, including "Typicals" must be validated for each customer application by customer's technical experts. Prisemi does not convey any license under its patent rights nor the rights of others. The products listed in this document are designed to be used with ordinary electronic equipment or devices, Should you intend to use these products with equipment or devices which require an extremely high level of reliability and the malfunction of with would directly endanger human life (such as medical instruments, aerospace machinery, nuclear-reactor controllers, fuel controllers and other safety devices), please be sure to consult with our sales representative in advance.

Website: <http://www.prisemi.com>

For additional information, please contact your local Sales Representative.

©Copyright 2009, Prisemi Electronics

 **Prisemi**[®] is a registered trademark of Prisemi Electronics.

All rights are reserved.